



Canon
AE-1
PROGRAM

INSTRUCTIONS
English Edition

Nomenclature

Shutter Speed Selector Dial

"A" Mark

Frame Counter

Finger Rest

Main Switch

Shutter Button (with Cable Release Socket)

AE Lock Pin

Action Grip

Battery Chamber Cover

Index

Focusing Ring

Aperture Ring

Bayonet for Hood

Shutter Speed Selector Dial Guard

Accessory Shoe

Battery Check/Self-timer Cancellation Button

Film Plane Indicator

Lock Release Button

Film Rewind Knob with Crank

ASA Film Speed Setting Lever

PC Socket

AE Lock Switch

Exposure Preview Switch

Stop-down Lever

Mount Positioning Point

Lens Release Button

Filter Thread

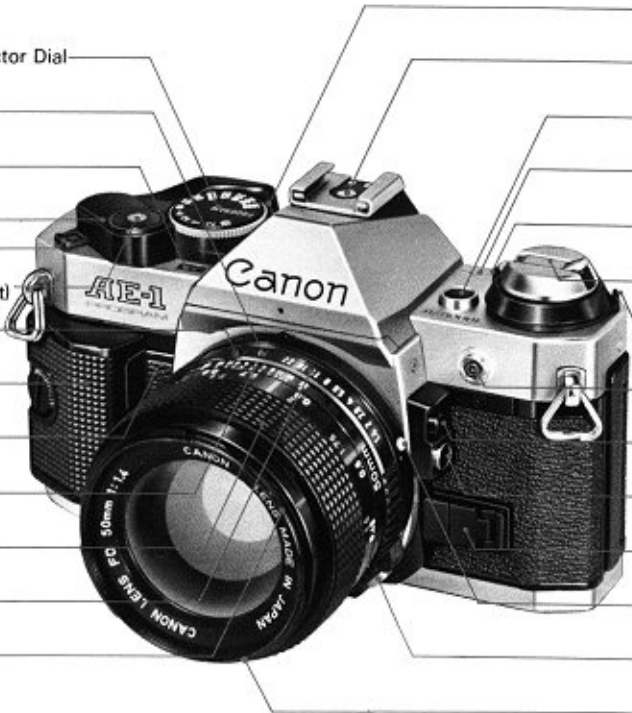

Basic Steps

1. Attaching the Lens	8
2. Setting the Lens for AE Photography	10
3. Loading the Battery	11
4. Checking the Battery	13
5. Learning to Operate Basic Controls	14
6. Setting the ASA	15
7. Loading the Film	16
8. Learning to Hold the Camera Correctly	19
9. AE Photography	20
1. Programmed AE Photography	20
2. Shutter-speed Priority AE Photography	22
10. One Shot at a Time	23
11. Rewinding the Film	24
• Self-Timer	25
• Dedicated Flash Photography with the Speedlite 188A	27
• Carrying the Camera	29
Pre-shooting Checklist	30
Care	31

Making the Most of Your AE-1 PROGRAM

12. Battery	32
13. Viewfinder	34
Viewfinder Information	34
Focusing	36
Exposure Warnings	39
14. Exposure	41
15. How to Choose a Shutter Speed	43
16. Shooting at Shutter Speeds Slower than 1/60 sec.	45
17. Aperture, Exposure's Other Half	47
How the Aperture Affects the Picture	49

18.	Checking the Depth of Field	51
19.	Shooting with Light Behind Your Subject (and Other Unusual Lighting Situations)	54
20.	Shooting with a Non-FD Lens	57
21.	Shooting with Close-up Accessories	59
	Film Plane Indicator	61
	Manual Diaphragm Control	62
22.	Flash Photography	63
	Display Information in AE Flash Photography	63
	Auto-exposure Flash Confirmation Signal	64
	Automatic Flash (with Ordinary Electronic Computer Flash Units)	65
	Manual Flash	66
23.	Shooting with Infrared Film	67
24.	Shooting in Very Low Temperatures	68
25.	Shooting at Night	69
26.	Interchangeable Focusing Screens	70
27.	Caring for Your Camera	72
28.	Optional Accessories	74
	Canon Power Winder A2	74
	Canon Motor Drive MA	75
	Canon Wireless Controller LC-1	75
	Data Back A	76
	Angle Finders A2 and B	76
	Lens Hoods	77
	Dioptric Adjustment Lenses S	77
	Magnifier S	78
	Filters	78
	Speedlites	79
	Specifications	82

1. Attaching the Lens

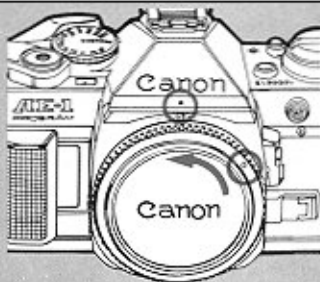

Turn the rear lens cap in the direction of the arrow until it stops and pull it off the lens.

Remove the body cap.

To reattach the rear lens cap, align it with the lens as illustrated. Then lightly push it in and turn it clockwise until it stops.



The instructions in this section concerning the lens are for an FD lens without a chrome mount ring. If your lens looks like this one with a chrome mount ring, read its instructions for handling the rear cap and mounting it on the camera.

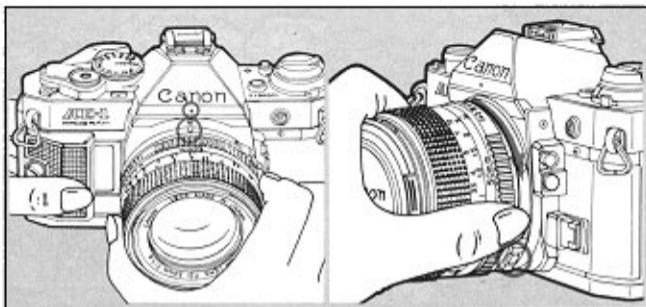

To mount the lens, first align the red positioning point on the lens with the red dot above the camera mount as illustrated.

Then turn the lens in the direction of the arrow until it stops and the lens release button pops out with a click.

Make sure the lens release button has popped out. Otherwise, the lens will not work properly. **DO NOT** press the lens release button while mounting or it may not pop out.

If your camera looks like this, with a red dot showing inside the camera mount, do not mount the lens yet; correct exposure cannot be ensured if you do. To release the stop-down lever, unfold and lightly press it down so it pops out. Then mount the lens. Leave the stop-down lever as it is.

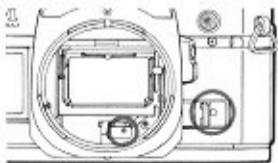

When film is loaded, make sure it is completely advanced to the next frame before mounting the lens.

2. Setting the Lens for AE (Automatic Exposure) Photography

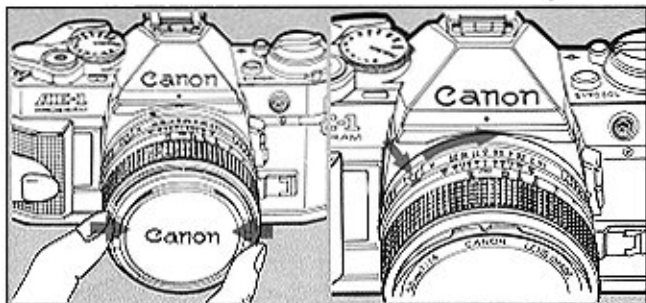

Remove the front lens cap.

While pressing in the AE lock pin, turn the aperture ring in the direction of the arrow until "A" click-stops at the distance index. "A" will be in line with the red dot on the camera. If you forget to do this, automatic exposure will be impossible. Note that both shutter-speed priority AE and programmed AE require this setting.

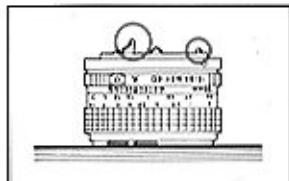

With the exception of the Canon Fish-eye 7.5mm f/5.6 lens, be sure to place the lens with its front end down (as illustrated) to avoid damaging the protruding pins.

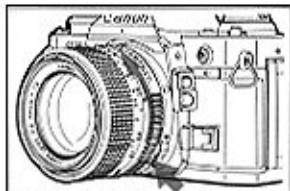

To remove the lens, turn it in the direction of the arrow, while pressing the lens release button, until it stops.

3. Loading the Battery

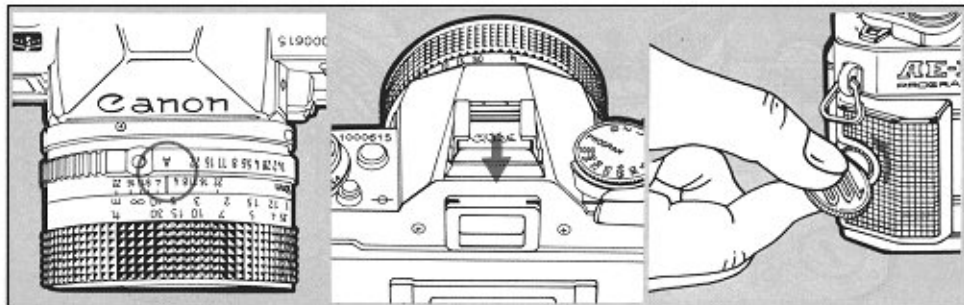

Remove the viewfinder cover from the accessory shoe.

Remove the action grip by means of a coin or similar object

Notes

1. AE photography is possible only with a Canon FD lens. See p. 57 for how to use a non-FD lens on the AE-1 PROGRAM.
2. Some Canon FD lenses have a green circle in place of the "A" mark. It means the same thing as the "A" mark.

Correct Batteries	Examples
Alkaline-manganese, 6V	Eveready (UCAR) No. A544 IEC 4LR44
Silver Oxide, 6V	Eveready (UCAR) No. 544 Duracell PX 28, IEC 4SR44
Lithium, 6V	Duracell PX 28 L

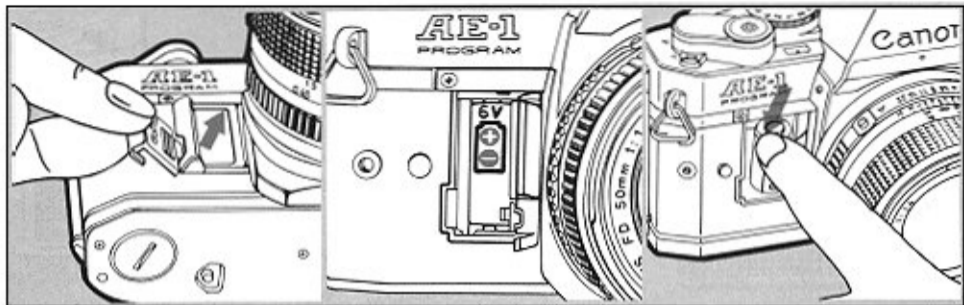

Open the battery chamber cover using the viewfinder cover.

Load a new battery so that its terminals are in the directions indicated by the diagram inside the battery chamber. The camera will not function if the battery is loaded incorrectly.

The AE-1 PROGRAM will not work without a battery. We recommend carrying a spare battery.

Insert the negative end first. Then push down and insert the positive end. Close the chamber cover.



Do not touch the battery terminals. Wipe them and the camera contacts with a clean, dry cloth before loading to prevent poor contact from dirt.

4. Checking the Battery

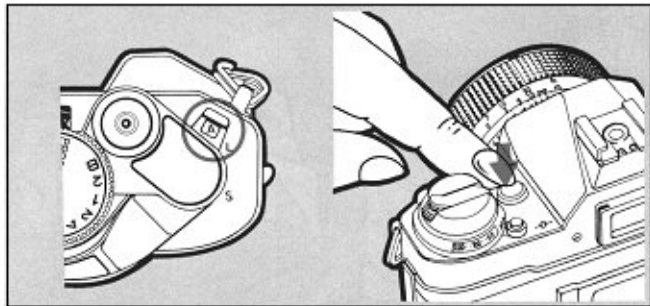

Turn the main switch to "A."

Press the battery check button. Shooting is possible if you hear about six or more "beeps" per second. If the camera beeps slowly (about three or fewer "beeps" per second), there is not enough power. In this case, replace the battery.

Notes

1. With normal use, the battery should last about one year.
2. It is necessary to take special precautions with the battery when you are shooting in temperatures below 0°C (32°F). See p. 68.
3. Remove the battery if you do not expect to use the camera for about three weeks or longer.

5. Learning to Operate Basic Controls

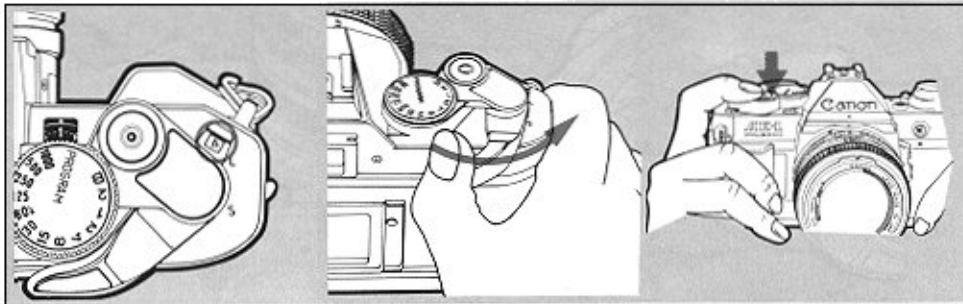

Make sure the main switch is on "A."

Turn the film advance lever in the direction of the arrow until it stops. You may turn it in one continuous stroke or in several short strokes. When film is loaded, this will advance it to the next frame.

The AE-1 PROGRAM has a two-step shutter button. Press it halfway to turn the meter on and to get a display in the viewfinder. Gently squeeze it all the way down to release the shutter. You cannot release the shutter again until the film is advanced.

Turn the main switch to "L" to prevent accidental shutter release or battery drain whenever you are not using the camera.

Never jab the shutter button! Pressing it gently is important for getting sharp pictures.

6. Setting the ASA

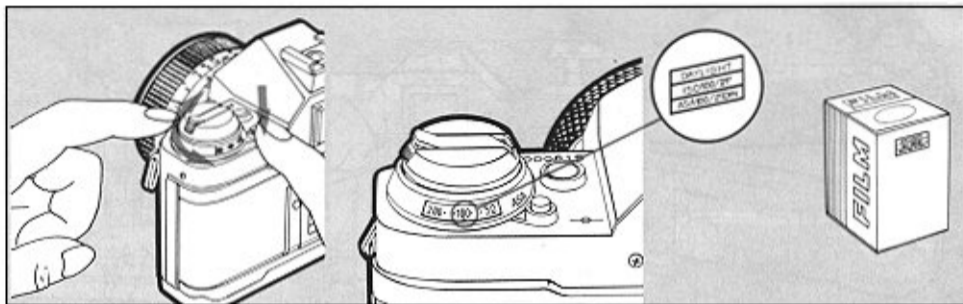

While pressing the lock release button, slide the ASA setting lever until the ASA speed of your film is aligned with the green index. This is necessary for getting correct exposure.

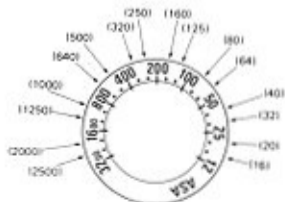

7. Loading the Film

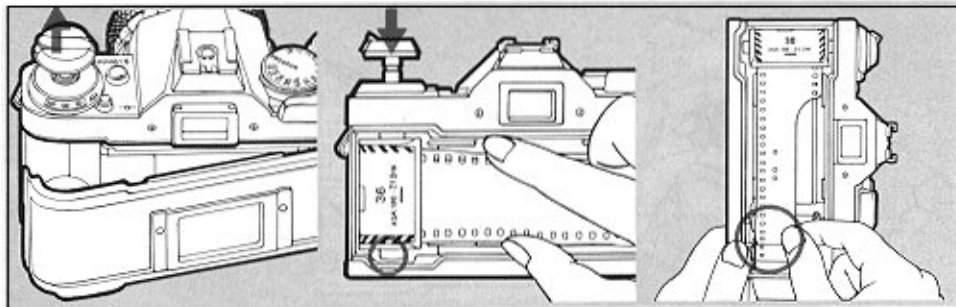

Pull up the rewind knob until the back cover pops open.

The AE-1 PROGRAM uses color (negative or slide) or black-and-white film in standard 35mm cartridges. Place the cartridge in the film chamber as shown. Then push the rewind knob down, turning it until it drops into its normal position.

Pull the film leader across the camera and insert it into any slot of the take-up spool.

A plastic insert is attached to the pressure plate of a new AE-1 PROGRAM to protect it in transport. Before loading the first film cartridge, remove this insert and throw it away.

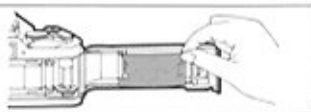

Shield the film from direct sunlight while loading.

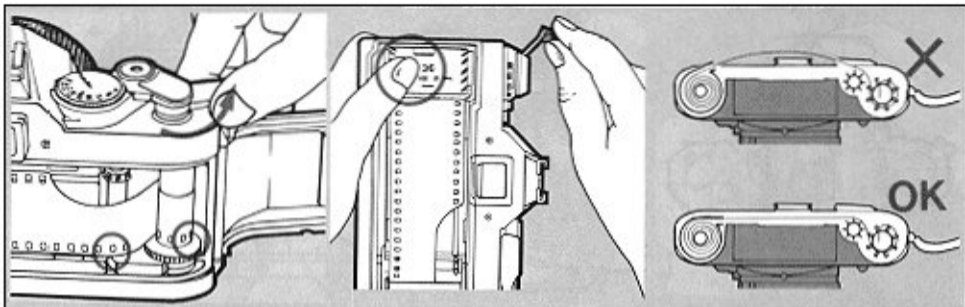

Advance the film once. Make sure the film perforations are engaged in the teeth of the film transport sprocket and the take-up spool.

The film should be taut. If there is slack, gently turn the rewind crank in the direction of the arrow until it stops. Close the back cover.

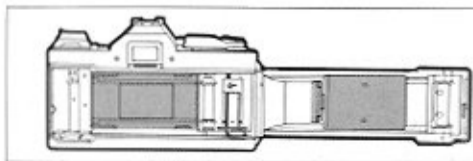

While loading the film, take care not to touch the shutter curtain, the film rails or the pressure plate (shown in red).

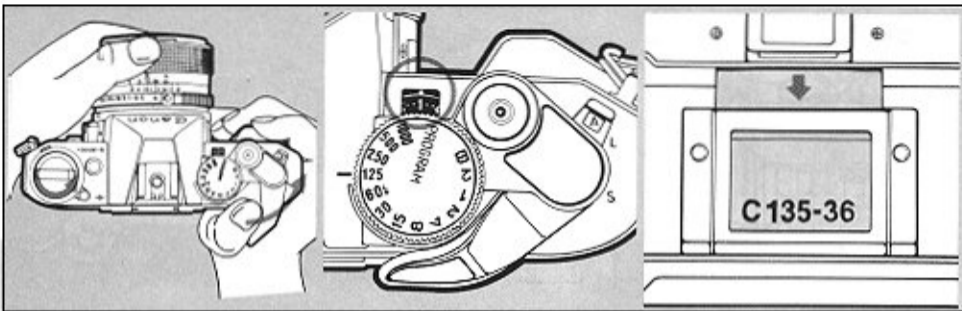

Take several blank shots, releasing the shutter and advancing the film, until the frame counter reads "1." While doing this, keep an eye on the rewind knob. If it rotates in the direction of the arrow, the film is loaded correctly.

Each time you advance the film, the frame counter also advances to the next frame. It can count up to 38 frames. The numbers 20 and 36 are in orange to call your attention to the fact that rolls with those numbers of frames are or are almost finished.

The back cover of this camera has a memo holder. It conveniently holds the end of the film box as a reminder of the type of film in use and the number of exposures.

Note
For film loading, in particular, do not set the shutter speed selector dial to "PROGRAM" if you have a lens cap attached to the lens or you are in dim light. We recommend setting the dial to any shutter speed from 1/125 to 1/1000 sec.

8. Learning to Hold the Camera Correctly



The slightest movement of your body during shutter release may cause blur in the picture. The best way to prevent camera movement is to hold the camera as steady as possible, with your left hand supporting the camera and lens. Press your left elbow to your body and lightly press the camera against your cheek or forehead. For a vertical shot, steady at least one elbow against your body. Spread your feet slightly apart, one



foot ahead of the other, and relax. Lean against a steady support if one is available.

Note

There is, of course, no one correct way to hold the camera. Experiment to find the most suitable way for you. Select a method that provides comfort in addition to stability. It may help to practice in front of a mirror.



9. AE Photography

The AE-1 PROGRAM offers the following two AE modes, either of which you can choose according to the shooting situation or personal preference.

(1) Programmed AE for those who prefer the camera sets both the shutter speed and aperture settings. The advantage of this exposure mode is that it allows you to concentrate fully on your subject.

(2) Shutter-speed priority AE for controlling the subject's movement. Faster shutter speeds can be used to freeze subject motion, and slower shutter speeds can provide artistic blur effects.

1. Programmed AE Photography

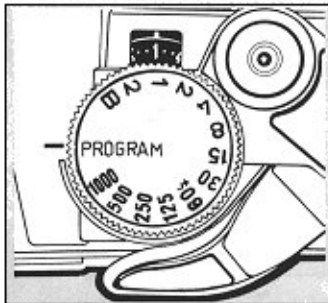

Turn the shutter speed selector dial until "PROGRAM" is aligned with the index.

Do not set the shutter speed selector dial between the click-stop settings. Note that it does not turn past "PROGRAM" or "B."

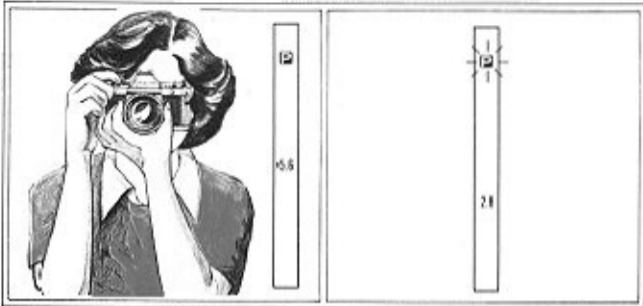

Look into the viewfinder and press the shutter button half-way. A green "P" and a number will appear to the right of the field of view, indicating programmed AE and the aperture selected automatically by the camera.

Exposure will be correct if the aperture display does not blink. The "P" will blink to warn you of camera shake when the shutter speed is 1/30 sec. or slower. If the "P" blinks, use a flash or attach the camera to a tripod. You can also use a film with a higher ASA rating.

When there is not enough light for correct exposure, the maximum aperture of the lens blinks; "16" blinks to indicate too much light.

Note

When shooting with a lens whose maximum aperture is f/1.8 or f/3.5, for example, the aperture display will indicate a maximum aperture of either f/1.4 or f/2, or f/2.8 or f/4 respectively.

See pp. 34-41 for further details on viewfinder information.

2. Shutter-speed Priority AE Photography

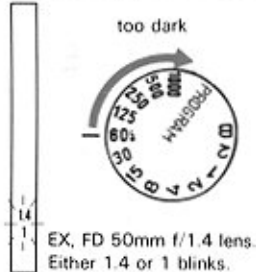
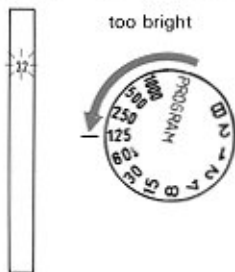
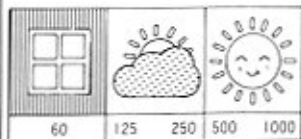

EX, FD 50mm f/1.4 lens.
Either 1.4 or 1 blinks.

Turn the shutter speed selector dial from "PROGRAM" and set a shutter speed. Refer to the illustrations above when choosing a shutter speed. While looking in the viewfinder, press the shutter release button halfway. Exposure will be correct as long as the aperture display does not blink.

In the case of an overexposure warning, "32" blinks regardless of the lens' minimum aperture. When using a lens whose minimum aperture is f/16 or f/22, even when "32"

Note

See p.45 if you must set the shutter speed selector dial to a number below "60." If action is a particularly important element in the shot, you may wish to refer to p.44 for more information on choosing a shutter speed.

does not blink, choose a faster shutter speed until the number displayed in the viewfinder is equal to or smaller than the lens' minimum aperture. To warn of underexposure, a number equal to or smaller than the lens' maximum aperture will blink. Choose a slower shutter speed until the aperture display stops blinking.

10. One Shot at a Time

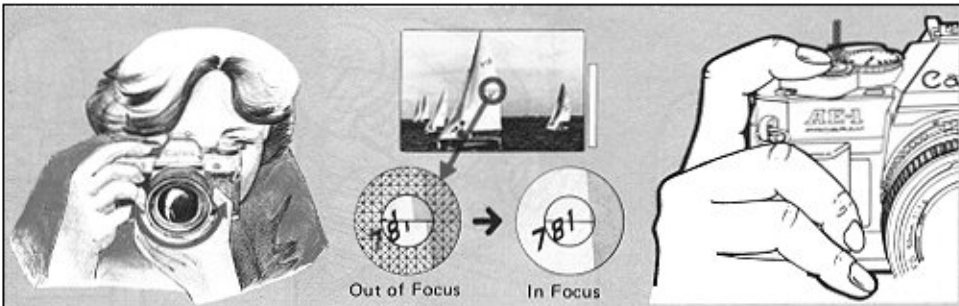

Turn the focusing ring until the main subject is sharp and compose the picture.

Gently press the shutter button all the way down to take the picture.

Note

If there is light, such as the sun or a window, behind your subject, see p.54 for details on exposure compensation.

Note

The AE-1 PROGRAM's focusing screen can be changed according to the subject you are shooting and the lens in use. See p. 70 for details.

11. Rewinding the Film

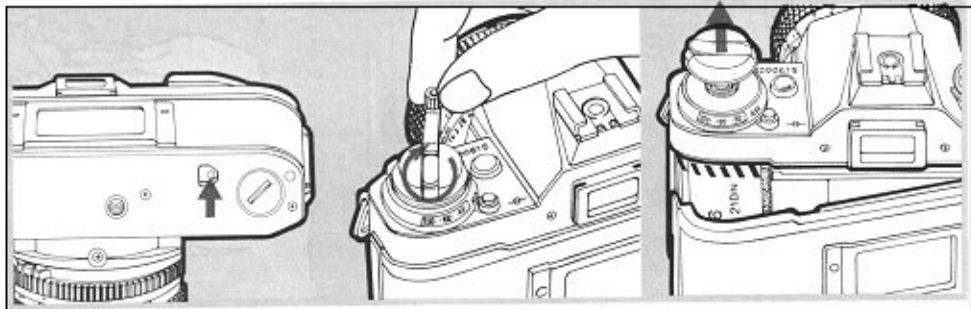

You can tell you have reached the end of the film by the frame counter and the film advance lever. Either the film advance lever will not turn at all or it will not turn all the way. First press in the rewind button.

Then turn the rewind crank in the direction of the arrow until the frame counter, which counts backwards as you rewind, reaches "S."

Then open the back cover, remove the film cartridge and place it back in its canister. It should be developed as soon as possible.

DO NOT open the back cover until you have rewound the film back into the cartridge. If you do, light falling on the film may ruin all of the pictures.

* Self-Timer

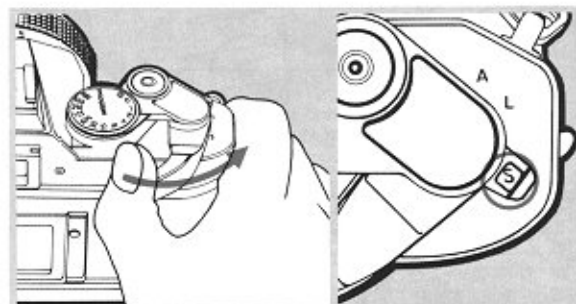

Advance the film to the next frame and focus your subject.

Set the main switch to "S."

To start the self-timer, press the shutter button. A "beep-beep" sound will be emitted. The shutter will be released automatically ten seconds later. At two seconds before shutter release, the camera will begin to beep at a faster rate.



Use the viewfinder cover to cover the eyepiece whenever your eye is not to it at the moment you take a shot. If it is uncovered, stray light entering from the rear may cause under-exposure.

The AE-1 PROGRAM sets the exposure the moment you press the shutter button. Do not stand in front of the lens while pressing the button or exposure may be incorrect.

Note

Following exposure, unless you want to use the self-timer for the next frame, reset the main switch to "A" or "L."

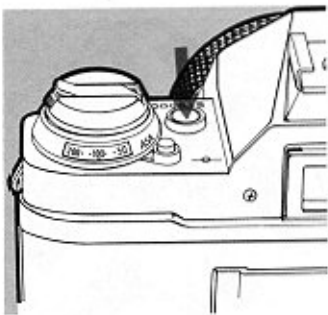

If you have started the self-timer and wish to cancel it before shutter release, press the battery check button or push the main switch back to "L."

A line drawing illustration of a man and a woman in an outdoor setting. The man is standing on the left, looking towards the woman on the right. The woman is holding a camera mounted on a tripod. A speech bubble originates from the woman, containing text.

Oh no! I started the self-timer but now I want to stop it. What shall I do?

A line drawing illustration of a man and a woman in an outdoor setting. The man is standing on the left, looking towards the woman on the right. The woman is holding a camera mounted on a tripod. A speech bubble originates from the man, containing text.

Try pressing the battery check button or pushing the main switch back to "L."

* Dedicated Flash Photography with the Speedlite 188A

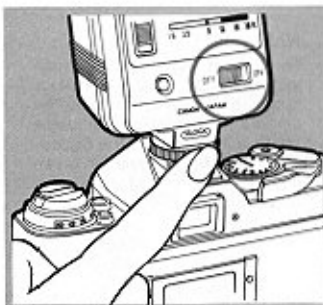

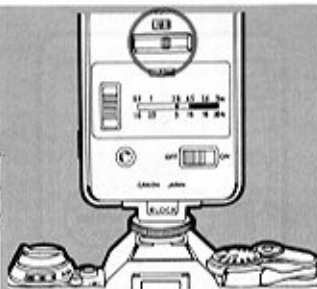

Make sure the main switch on the flash is OFF. Then slide the flash into the AE-1 PROGRAM's accessory shoe. Tighten the lock nut.

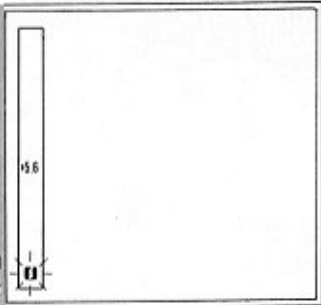

Slide the Speedlite's ASA film speed switch to the ASA speed of your film. Then push the Aperture/MANU selection switch to select an aperture. The green and red positions each indicate the distance range which corresponds to the aperture you have set on the flash.



Turn the Speedlite's main switch ON. When the flash is charged, its pilot lamp will glow. When the shutter button is depressed halfway, the auto working aperture and a green  will appear in the viewfinder, indicating that the flash is charged. Immediately following shutter release, continue to press the shutter button halfway; the green  will flash on and off for two seconds if your shooting distance provided correct exposure.

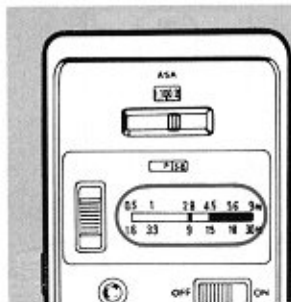

Note

For correct exposure, the subject must be within a certain range of distances from the camera. The required distance range is indicated on the Speedlite 188A by the red or green line.

Notes

1. Canon offers six other Speedlites for the AE-1 PROGRAM. With slight differences, all seven are used in almost the same way. See page 63 and the Speedlite's instructions for more details. Make sure the AE-1 PROGRAM's shutter speed selector dial is not on "B." Any other setting is okay.

2. If the **U** does not flash on and off for two seconds after shutter release, change your shooting distance so it is within the distance range specified on the flash.

* Carrying the Camera

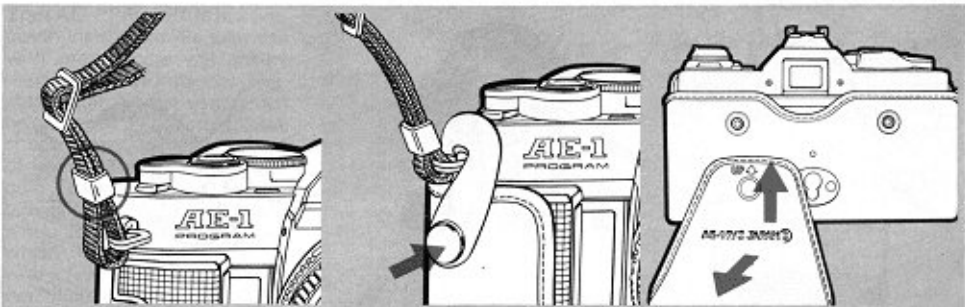

Thread the ends of the strap through the rings on the camera as shown.

For carrying the camera, in particular, insert it into its semi-hard case (optional accessory) as shown.

To remove the top cover, turn it down, then push it straight up and out. Turn the lens' focusing ring to infinity (∞) before closing the top cover.

Note

Do not forget to turn the main switch to "L" to prevent accidental shutter release while carrying the camera.

Pre-shooting Checklist

Shutter speed selector dial set to "PROGRAM" (for programmed AE) or to a shutter speed (for shutter-speed priority AE)?



Battery?



Lens aperture ring set to "A"?



ASA setting?



Film Advance?

Care

Your AE-1 PROGRAM is a precision instrument. Regular use with proper care will ensure maximum performance. Reliable under normal use, it can be damaged by moisture, heat, shock, water, sand or the use of force. We recommend periodic external cleaning with a blower brush and lens cleaning with lens cleaning tissue which has been moistened with a few drops of lens cleaning fluid. During prolonged storage, remove the camera from its case and wrap it in a clean, soft cloth. Remove the battery. See pp. 72-73 for additional tips on camera and lens care.

Making the Most of Your AE-1 PROGRAM



12. Battery

1. Correct Batteries Examples

Alkaline-manganese 6V	Eveready (UCAR) No. A544 IEC 4LR44
Silver Oxide 6V	Eveready (UCAR) No. 544, Duracell PX 28 IEC 4SR44
Lithium 6V	Duracell PX 28 L

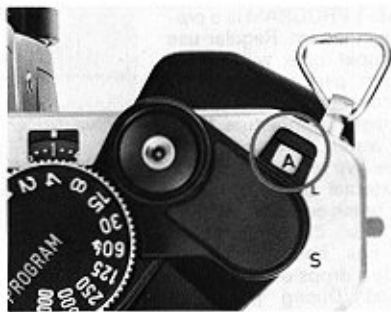

- The AE-1 PROGRAM's battery check circuit not only tells you whether the battery is good but also how good it is. First make sure the main switch is on "A." Then press the battery check button for two to three seconds. If the battery's power is sufficient, the camera will emit about six or more "beeps" per second. If the battery is weak and needs replacing, the camera will beep at the slower rate of about three "beeps" or fewer per second.
- The battery is exhausted if, after pressing the battery check button for about three seconds, no sound is emitted. Replace the battery with a new one.



4. Pressing the battery check button, the shutter button, the exposure preview switch, or the AE lock switch uses battery power. Take care that nothing presses on any of these when the camera is not in use.
5. Remove the battery if you do not expect to use the camera for about three weeks or longer. With normal use, the battery should last about one year.
6. Do not try to take the battery apart and never dispose of it in fire.

7. Try to make a habit of checking the battery at the following times:
 - After loading a new battery.
 - If the shutter won't function when the main switch is on "A."
 - Before and after making many long exposures.
 - After storing the camera for a long time.
 - When you are using the camera in low temperatures (see p.68).
 - Before going on a trip.
 - When the camera is used very frequently.
 - Before shooting important events.

13. Viewfinder

Viewfinder Information

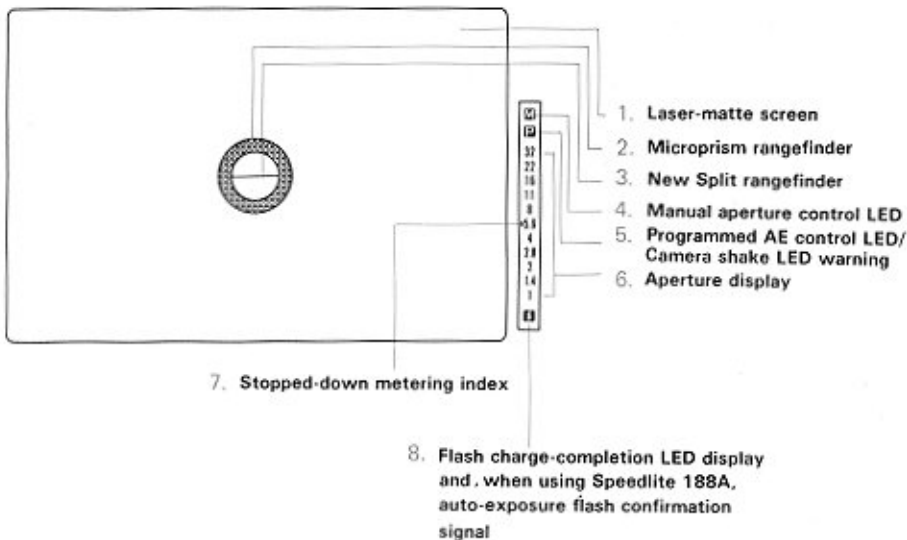

The AE-1 PROGRAM's viewfinder is especially bright to facilitate viewing and focusing. It displays only the necessary information, using a Light-Emitting Diode (LED) system of illumination. The degree of LED illumination changes in four stages depending on the brightness of the subject. When the subject is brighter, the LED brightness is slightly higher; it is slightly lower with a darker subject. Thus the LED maintains an almost consistent degree of brightness to the human eye.

Correct exposure is provided by the Central Emphasis Averaging System, which reads the entire viewing area with emphasis on the central portion where the subject is most likely to be placed. Since a new type of split-image rangefinder is used in the center of the viewfinder, the brightness of the split-image rarely changes even when using a lens whose maximum aperture is $f/5.6$ or smaller.

Focusing



Out of Focus

1 - 3 are aids to help you focus. They can be used alone or in combination. The New Split rangefinder 3 divides the subject in half horizontally and is especially useful for a subject which has vertical lines. The subject is in focus when the two halves merge to become one unbroken image. When it is difficult to focus the subject, use the laser-matte screen.



In Focus

When the subject is out of focus, the micro-prism ring 2 breaks the subject into tiny fragments, causing a shimmering effect. It is clear and steady when your subject is in focus.

The laser-matte screen 1 appears fuzzy until the subject is in focus. It is particularly effective when you are using accessories for copying or close-ups. See p. 60.

Canon offers eight different types of interchangeable focusing screens. See p. 70 for further details.

*When using a lens with a maximum aperture of $f/5.6$ or smaller, half of the split-image rangefinder may take on a slight color.

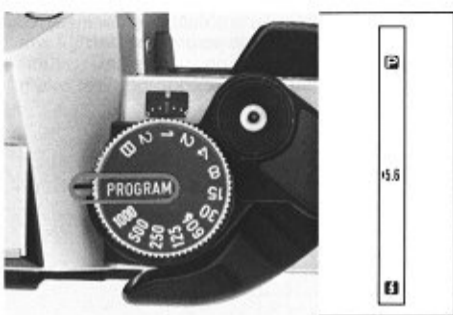

When the lens' aperture ring is set to "A" and the shutter speed selector dial to "PROGRAM," a green "P" LED 5 is displayed, indicating programmed AE photography.

If the shutter speed selected automatically by the camera is 1/30 sec. or slower, the "P" will blink. This is to warn you that your picture may be blurred due to camera movement if you are hand-holding the camera.

The aperture selected automatically 6 by the AE-1 PROGRAM is displayed in the viewfinder.

The meter index 7 is for setting exposure with a non-FD lens and in close-up photography (see pp. 57-58).

When using a Canon Speedlite 133A, 155A, 177A, 188A, 199A, 533G or 577G, a green flash charge-completion signal 8 lights up when the flash is charged.

When using the Speedlite 188A, this signal 8 flashes on and off for two seconds after the shutter is released if the flash-to-subject distance was within the auto coupling range.

Meter coupling range

When using an FD 50mm f/1.4 lens and ASA 100 film, the built-in exposure meter couples within a range of EV1 (f/1.4 at 1 sec.) to EV18 (f/16 at 1/1000 sec.). At given film speeds, the built-in exposure meter couples with the aperture and shutter speed, as indicated in the chart on the next page. If the shutter speed and aperture combination are outside the coupling range, the camera warns you by flashing the appropriate display inside the viewfinder.

The dotted line indicates the meter coupling range in programmed AE.

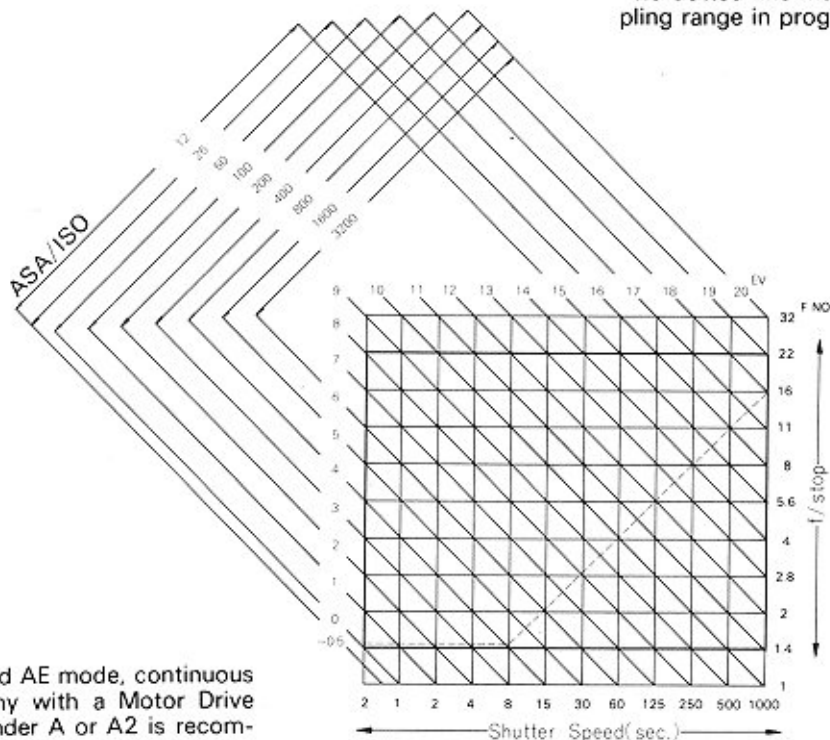

In the programmed AE mode, continuous frame photography with a Motor Drive MA or Power Winder A or A2 is recommended only if the light is bright enough to give an aperture display of f/4 or larger. In this case, the shutter speed will be at least 1/60 sec.

Exposure Warnings

When taking pictures in excessively bright or low light, the aperture display blinks in the viewfinder. Depending on the warning displayed, make the appropriate adjustment as follows.

Besides pressing the shutter button halfway, you can also turn the meter on to check exposure in the viewfinder by pressing the exposure preview switch. Pressing it uses battery power. Be careful not to press it unintentionally.

Overexposure Warning

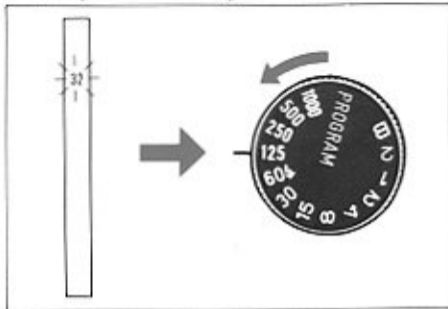

Shutter-speed priority AE mode: "32" blinks regardless of the minimum aperture of the lens in use. Choose a faster shutter speed until the display stops blinking. When using a lens whose minimum aperture is f/22 or f/16, even when "32" does not blink, turn the shutter speed selector dial until a number equal to or smaller than the lens' minimum aperture is displayed.

Underexposure Warning

Shutter-Speed
Priority AE mode



Programmed AE mode

Use ND Filter or
film with a lower
ASA rating.



(example)



Shutter-speed priority AE mode: When "32" blinks and the shutter speed selector dial is set to 1000; or

Programmed AE mode: When "16" blinks, you can

- Attach an ND filter; or
- Use a film with a lower ASA rating.

Shutter-speed priority AE mode: A number equal to or smaller than the lens' maximum aperture blinks. Choose a slower shutter speed so that the aperture stops blinking.

*An ND (neutral density) filter reduces the light intensity while having no effect on colors. Optional.

14. Exposure

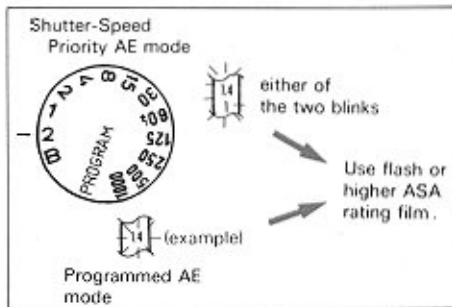

Shutter-speed priority AE mode: When 2 sec. is set on the shutter speed selector dial and a number equal to or smaller than the lens' maximum aperture blinks; or

Programmed AE mode: When the lens' maximum aperture blinks,

- you can
- Use flash or other additional light; or
 - Use a film with a higher ASA rating.

With the shutter button pressed halfway, a red "M" LED 4 appears whenever you remove the aperture ring of the lens from "A" or when you mount a non-FD lens. See pp. 57—58. It warns you that exposure will not be automatic.

Taking a picture is a matter of letting light fall on the film under controlled conditions. This is called exposure. When you press the shutter button, some blades (called a diaphragm) inside the lens shift to form an opening called the aperture. Almost simultaneously, the first shutter curtain starts to move inside the camera. A second shutter curtain follows it after a fixed interval which you control with the shutter speed selector dial. The amount of light that exposes a frame depends on the shutter speed and the size of the aperture.

For the same exposure, a change in the shutter speed requires an equal and opposite change in the aperture. The AE-1 PROGRAM makes this

change in aperture automatically by means of the shutter-speed priority AE mode. In programmed AE, the camera automatically chooses a combination of shutter speed and aperture for correct exposure.

There are usually several combinations of shutter speed and aperture which will give the same exposure. This fact is the key to one of the most creative tools in photography. Find out more about it in the next three sections.

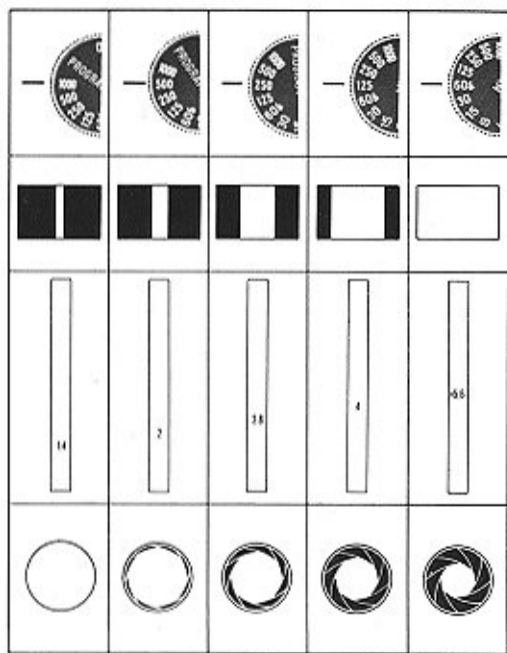

15. How to Choose a Shutter Speed

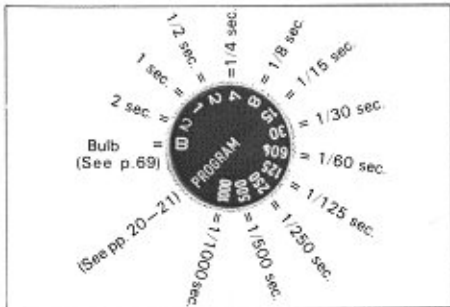

The shutter controls exposure by the length of time it remains open.

The basic function of shutter speed is to get correct exposure, but you can also use it to control the expression of your subject's motion and to control the effect of camera movement.

Blurring part of the picture can heighten the sense of action. In most cases, however, image blur is undesirable. To avoid blurred pictures from camera movement, use a shutter speed of at least 1/60 second for handheld shooting with a standard (50 mm) lens. Even higher speeds are necessary with a telephoto lens. See pp.45-46.

I wonder what ASA film speed is.

Oh, I forgot to tell you. I asked our film dealer about that. He told me that the higher the film's ASA speed, the less the light it needs for exposure.



That must mean that with a higher film speed we can shoot in lower light or use faster shutter speeds. Good work!





1. Freezing Motion

Usually a certain shutter speed is chosen to freeze the motion of a subject. The faster the subject is moving, the higher the shutter speed required to stop the action. While it is possible to freeze the motion of a pedestrian at $1/60$ second, you need $1/1000$ second for a moving train. The motion of the bird in this photo was frozen at $1/1000$ second.



2. Blurring the Subject's Motion

Blurring part of the picture intentionally can give a convincing sense of action. To blur the subject, simply set a shutter speed which is too slow to freeze its action. In this photo it was blurred at $1/125$ second.

You can also blur the background by "panning." Choose a shutter speed suitable for the subject's motion and release the shutter as you follow the movement, turning the upper part of your body. See p. 87 for a colorful example.

16. Shooting at Shutter Speeds Slower Than 1/60 Sec.

With a standard 50 mm lens on your AE-1 PROGRAM, a shutter speed of 1/30 second or slower is liable to result in blurred pictures because of camera movement when you are handholding the camera. Instead of using such slow shutter speeds, it is better to raise the shutter speed, if possible, add light or use a flash.

If you cannot do any of these things, mount the camera on a sturdy tripod and use a cable release. Attach the camera to the tripod via the tripod socket. A cable release is an accessory which screws into a socket in the shutter button and allows you to release the shutter without touching the camera.

With a wide-angle (less than 50 mm) lens, it may be possible to use shutter speeds slightly slower than 1/60 second for handheld shooting. With a telephoto (more than 55 mm) lens, even faster shutter speeds are necessary to prevent blurring.

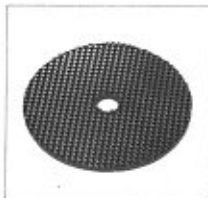

Note

Canon offers an optional accessory called Tripod Adapter A. If the tripod head is quite large, it may be helpful to place this accessory between the camera and the head. Otherwise, it may be difficult to turn the focusing and aperture rings. This accessory also prevents damage to the camera when the tripod screw is too long for the camera's tripod socket.

I wonder what we're supposed to do if we don't have a flash or a tripod and a cable release?



Let's try steadying the camera on this table and then releasing the shutter with the AE-1 PROGRAM's self-timer. I'm sure it will reduce the possibility of camera movement.



Rule of Thumb:

Generally, do not use a number on the shutter speed scale which is any smaller than the focal length of the lens for handheld shooting. For handheld shooting with a 100 mm lens, for instance, set a shutter speed of 1/125 second or faster; with a 200 mm lens, at least 1/250 second. If this is not possible, use a tripod and a cable release.

Note

In the programmed AE mode, the "P" blinks when the shutter speed is 1/30 or slower to warn you of the possibility of camera movement if you are handholding the camera.

17. Aperture, Exposure's Other Half

Maximum Aperture
(large f/stop)

Minimum Aperture
(small f/stop)

Note: The smaller the number, the larger the aperture.



[Example Shown: FD 50mm f/1.4. Maximum and minimum apertures differ depending on lens]

The lens has diaphragm blades. They open and close to form certain-sized holes, or apertures, which control the amount of light allowed to expose the film. The aperture scale can be found on the lens' aperture ring. The numbers on the scale are called f-numbers or f/stops.

When taking pictures using shutter-speed priority AE or programmed AE, the lens' aperture ring must be set to the "A" mark. With the lens on this setting, the AE-1 PROGRAM automatically selects the correct aperture, based on lighting, the film speed, and the shutter speed. When you press the shutter button halfway, the f/stop the AE-1 PROGRAM has set auto-

matically appears in the viewfinder. Because the meter reads light continuously, as the lighting conditions change, the different apertures which compensate for the change appear in the viewfinder. The AE-1 PROGRAM does not fix the aperture until you press the shutter button to take the picture.

In addition to controlling the quantity of light, the aperture influences depth of field which, in turn, affects the way a picture will look. When your subject is in focus, there is a certain area in front of it and behind it which will also be in focus. This range of sharpness is called depth of field.

In portraits and still-life shots, a particular aperture may be more important to your picture than a particular shutter speed. To get the aperture you want in shutter-speed priority AE, simply turn the shutter speed selector dial, while pressing the exposure preview switch, until the desired f-number appears in the viewfinder. Keep in mind that the shutter speed should not be slower than 1/60 second for handheld shooting with a standard lens.



How the Aperture Affects the Picture

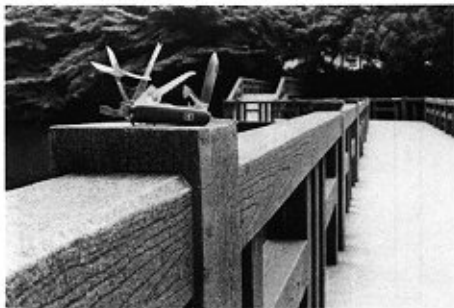

1. The smaller the aperture, the wider the range of sharpness. This is illustrated by this picture above which was taken at $f/16$. Compare it with the photo to its right. This extended depth of field is especially good for such subjects as landscapes.

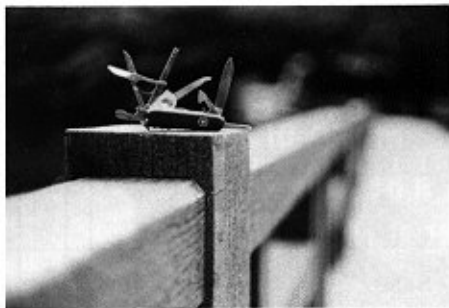

2. The larger the aperture, the narrower the range of sharpness. An aperture of $f/1.4$, for instance, can isolate your subject from its surroundings. This is often used to blur a disturbing background in portraiture.

Notes

Depth of field is also greater the shorter the focal length of the lens. For example, a 24 mm lens will show greater depth of field than a 50 mm lens, provided the aperture and shooting distance are the same. Depth of field is also greater the longer the shooting distance, and is generally greater in the background than in the foreground by a ratio of two to one.

With a Canon FD lens, viewing and metering are done at maximum aperture where the viewfinder is brightest. The lens diaphragm does not close to the shooting aperture until the shutter is released. Afterwards, it reopens automatically to the maximum aperture. Because the maximum aperture provides the narrowest range of sharpness, the subject is viewed with the shallowest depth of field.

18. Checking the Depth of Field

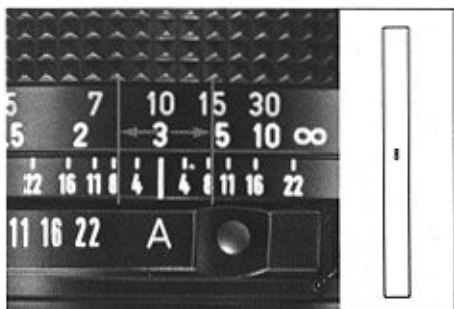

There are two ways to check the depth of field. The usual one is by using the depth-of-field scale on the lens. This is a scale of f/stops repeated on each side of the distance index.

1. First focus. Then press the shutter button halfway and note which number appears in the viewfinder. Find the two f/stops on the depth-of-field scale which correspond to that number.
2. Draw imaginary lines from those two numbers to the distance scale. The effective depth of field lies between those two distances.

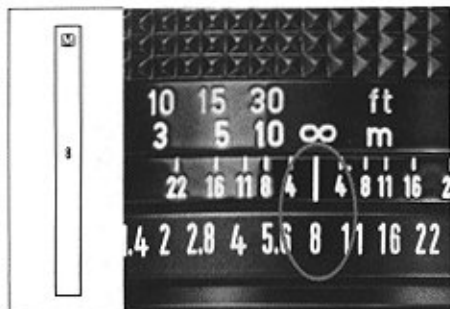

You can roughly check the depth of field visually with an FD lens as follows:

1. Make sure the film has been completely advanced.
2. Press the shutter button halfway to find out which number is displayed in the viewfinder.
3. Then press in the AE lock pin and turn the aperture ring to that number.

Note

As a reminder that the lens is off "A," the "M" will light up in the viewfinder when you press the shutter button halfway.



4. Push in the stop-down lever until it locks. Now, just by looking at your subject through the viewfinder, you can see the range of sharp focus.



5. After checking the depth of field, unlock the stop-down lever. Now turn the aperture ring to the smallest number. Then turn it to the largest number, press the AE lock pin and return the aperture ring to "A."

Do not push in the stop-down lever before you advance the film or the diaphragm will close down only as far as the aperture used for the previous exposure.
When an FD lens is mounted DIRECTLY on the camera (with no accessories between), NEVER take a shot before releasing the stop-down lever or exposure may be incorrect. And unless you want to make an exposure correction (p. 55) return the aperture ring to "A" before shooting.

It is impossible to push in the stop-down lever when an FD lens is set at "A."

6. Now you can take your shot.



Try turning the aperture ring to the smallest number for viewing. Then, while looking at objects in the foreground and background, turn the aperture ring to the aperture you'll be using.

Hey! There must be something wrong. The viewfinder is getting darker and it's difficult to focus.



Oh, I see. you're previewing the depth of field. As you turn the aperture ring to a higher number, the diaphragm closes down and lets less light in.



Oh, I see now. There's more in focus!



19. Shooting with Light Behind Your Subject (and Other Unusual Light-



Exposure Correction

When there is light, such as the sun or a bright window, behind your subject, the AE-1 PROGRAM's meter may be overinfluenced by that light and your subject will come out too dark. You can correct the exposure by (1) pressing the AE lock switch; (2) adjusting the ASA; or (3) manually setting both the shutter speed and aperture (canceling AE photography).



I. AE Lock Switch

For example, when shooting a backlit subject:

- 1) Approach your subject and, looking in the viewfinder, center your subject so that it takes up about one-third of the viewing area.
- 2) While pressing the shutter button halfway, press the AE lock switch.
- 3) Keeping the shutter button pressed halfway, step back, compose the picture as you like, and shoot. Your subject will be correctly exposed.

You do not have to continue pressing the AE lock switch; the exposure value is retained as long as you press the shutter button halfway.



2. Adjusting the ASA

Sometimes, in a theater or concert hall, for instance, where it is quite dark, the AE-1 PROGRAM's meter may be overinfluenced by the darkness and your subject will come out too light. To expose your subject correctly, turn the ASA film speed lever to a higher number. Each full step on the ASA film speed scale equals one f/stop. If ASA 200 film is loaded, for instance, and you turn the lever to ASA 400, your subject will receive one f/stop less exposure. Exactly how much higher you should set the ASA film speed depends on the situation. To be on the safe side, you may wish to bracket the exposure (see "Note #2," next page).

3. Manual Override

Instead of using the AE lock switch or changing the ASA, you can also make an exposure correction by canceling AE photography. When you do this, you will be setting both shutter speed and aperture by yourself. This is called manual override and is useful whenever you want to set a different aperture than the one the AE-1 PROGRAM would select automatically in AE.

Note

Just as doubling the ASA will underexpose the picture one f/stop, halving it (setting the lever to ASA 100 for ASA 200 film) will overexpose the picture one f/stop.

Following exposure, do not forget to reset the film speed lever to the correct ASA film speed, or all following frames will be incorrectly exposed!



1. Set a shutter speed by turning the shutter speed selector dial.
2. Remove the lens from "A" and set an aperture by turning the aperture ring.

Notes

1. When you press the shutter button halfway, the aperture that the AE-1 PROGRAM would select automatically will light up. You may wish to use this aperture reading as a basis for setting an aperture on the aperture ring. A red "M" will light up in the viewfinder to remind you that the lens is removed from "A."
2. You may find it worthwhile to bracket the exposure. This means taking several shots at different exposures so that at least one of them turns out correctly exposed. Take the first shot at the exposure you think is right. Then take two more, one with the aperture ring set one step higher and the other with it set one step lower. It is possible to do the same thing by changing the ASA setting or the shutter speed.

20. Shooting with a Non-FD Lens



With a Canon FD lens, metering is done with the lens diaphragm at its widest opening. This is called "full-aperture metering."

Stopped-down Metering

With a Canon FL lens, the TS 35mm lens or any other non-FD lens, full-aperture metering is not possible. The lens must actually be closed (stopped down) to the shooting aperture for metering. This is called "stopped-down metering." In stopped-down metering, the lens diaphragm will open or close as you turn the aperture ring.

1. Push the stop-down lever towards the lens until it locks.

2. Make sure the shutter speed selector dial is NOT on "PROGRAM."
3. While pressing the shutter button, turn the aperture ring until the stopped-down metering index and 5.6 appear. Correct exposure cannot be obtained with any other display.
4. Press the shutter button all the way down for exposure.

Notes

1. Stopped-down metering is not possible when the shutter speed selector dial is set to "PROGRAM."
2. You can also press the exposure preview switch and turn the shutter speed selector dial until the stopped-down metering index and 5.6 appear.
3. Once the lens is stopped down, you can check depth of field visually simply by inspecting the subject through the viewfinder.

Lenses which cannot be mounted on the AE-1
PROGRAM:

- FL 19mm f/3.5
- FL 58mm f/1.2
- R 58mm f/1.2
- R 100mm f/3.5
- FLP 38mm f/2.8

Lenses which cannot be used with the AE-1
PROGRAM's meter for mechanical reasons:

- FL 50mm f/1.8
- FL 35mm f/2.5
- R 50mm f/1.8
- R 35mm f/2.5
- R 100mm f/2

NEVER try to do stopped-down metering with an FD lens unless there are close-up accessories between it and the camera. If you do stopped-down metering when an FD lens is mounted directly on the camera, exposure may not be correct.

21. Shooting with Close-up Accessories



With few exceptions (noted in the instructions for the accessory), stopped-down metering is necessary whenever you insert an accessory between the camera and lens for close-up photography.

1. If you insert an accessory designed for **AUTOMATIC** diaphragm control, such as the Auto Bellows or Bellows FL, between the camera and **ANY** lens, follow the steps (p. 57) for stopped-down metering.
2. If you insert an accessory designed for **MANUAL** diaphragm control, such as M Extension Tubes or Bellows M, between the camera and a **NON-FD** lens, follow the steps (p. 57) for stopped-down metering. Turn the A-M ring of an FL lens to "M" for taking the shot (not necessary if Canon Macro Auto Ring and Double Cable Release are used).
3. If you insert an accessory designed for **MANUAL** diaphragm control between the camera and an **FD** lens, unless you use the Canon Macro Auto Ring and Double Cable Release, first set the lens for manual diaphragm control before mounting it on the accessory. Then follow the steps (p. 57) for stopped-down metering.

Note

The instructions with the accessory will tell you whether or not manual diaphragm control is necessary. The procedure differs according to the type of lens. See page 62.

Film Plane Indicator

This mark, engraved on top of the camera body, indicates the exact position of the film plane. It is useful for measuring the exact shooting distance from film to subject in close-up photography. Distances on the lens' distance scale are calibrated from this mark. It is not used in general photography.



Note

The aperture ring of an FD lens must be removed from "A" before you mount the lens on any of these close-up accessories except for FD-U Extension Tubes and Extenders FD 2x and FD 1.4x, which are designed for normal full-aperture metering.

Manual Diaphragm Control



FD Lens without Chrome Mount Ring except for FD Macro Lenses

1. Insert the slot of the accessory manual diaphragm adapter over the tip of the automatic aperture lever at the rear of the lens. Push the lever counterclockwise and lower the adapter into the groove. The diaphragm blades will open or close as you turn the aperture ring.

2. Mount the lens on the accessory.
When the manual diaphragm adapter is attached, NEVER mount the lens DIRECTLY on the camera or on an accessory designed for automatic diaphragm control, such as the Auto Bellows or Bellows FL.



FD Lens with Chrome Mount Ring and FD Macro Lenses (except for FD 200mm f/4 Macro Lens)

1. Push the automatic aperture lever at the rear of the lens counterclockwise until it automatically locks.
2. Mount the lens on the accessory.

Note

Some of these lenses have an additional lock lever. With these lenses, push the automatic aperture lever fully counterclockwise, then push the lock lever to "L."



Be sure to reset the automatic aperture lever to its normal position before mounting the lens DIRECTLY on the CAMERA. In the case of a lens with a lock lever, switch it back to the position of the white dot.

22. Flash Photography



Display Information in AE Flash Photography

Flash Charge-completion Display (with Speedlites 133A, 155A, 177A, 188A, 199A, 533G, and 577G)

When the Speedlite is charged and the shutter button is pressed halfway, a green  and the auto working aperture light up in the viewfinder display. After the shutter is released, the AE-1 PROGRAM switches automatically to normal AE photography until the pilot lamp and green  glow again.

Notes

1. Except when the shutter speed selector dial is set to "B," the AE-1 PROGRAM automatically switches to 1/60 sec. as soon as the Speedlite's pilot lamp and the green  glow.
2. Since the AE-1 PROGRAM displays only full apertures in the viewfinder, the aperture displayed may be one-half f/stop larger or smaller than the auto working aperture set on the flash; the auto working aperture is the effective aperture.

Auto-exposure Flash Confirmation Signal

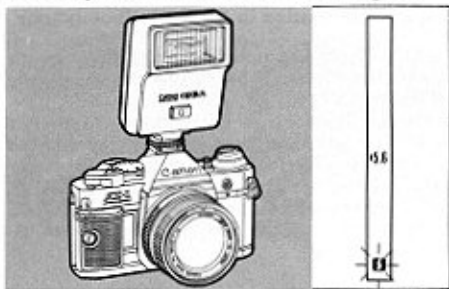

(with the Speedlite 188A only)

After the shutter is released, continue to press the shutter button halfway; the green  will flash on and off for two seconds if the shooting distance provided correct exposure.

Note

The auto-exposure confirmation signal displayed in the viewfinder is for use with the Speedlite 188A. When using other flash units, the  may flash on and off after the shutter is released. In such cases, however, it does not confirm auto-exposure and should be disregarded.

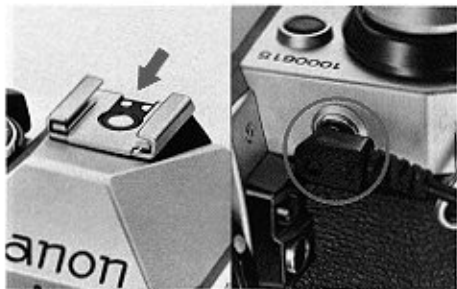

The AE-1 PROGRAM has two flash terminals.

1. Insert a direct-contact hot-shoe type flash directly in the accessory shoe. For this type of flash, no other connection is necessary.
2. If you use a flash which requires a synchronization cord, branch the cord between the flash and the camera's PC socket.

Notes

1. Before mounting a flash unit, make sure its power switch is OFF.
2. Two flash units can be fired simultaneously by placing one in the accessory shoe and connecting the other to the PC socket.
3. It is recommended to use a Canon flash unit on this camera. Using a flash or flash accessory of another make may cause the camera to work improperly or even possibly damage the camera itself.

Automatic Flash (with Ordinary Electronic Computer Flash Units)

1. Turn the AE-1 PROGRAM's shutter speed selector dial to 1/60 second.
2. Remove the aperture ring of an FD lens from "A" and turn it to the automatic aperture which you have set on the flash.

Note

For more details, see the instructions for the flash.

Manual Flash

1. Set the shutter speed selector dial according to the information in the table below:

Type		Synchronized shutter speed													
		$\frac{1}{1000}$	$\frac{1}{500}$	$\frac{1}{250}$	$\frac{1}{125}$	$\frac{1}{60}$	$\frac{1}{30}$	$\frac{1}{15}$	$\frac{1}{8}$	$\frac{1}{4}$	$\frac{1}{2}$	1	2	B	
Flash Bulbs	FP class						△	○	○	○	○	○	○	○	
	M and MF class						△	○	○	○	○	○	○	○	
Electronic Flash						○	○	○	○	○	○	○	○	○	

2. Calculate the aperture with a guide-number formula or with the flash unit's calculator dial if it has one. Turn the lens' aperture ring to that aperture.

○ = okay

△ = possible unevenness in picture depending on bulb

23. Shooting with Infrared Film

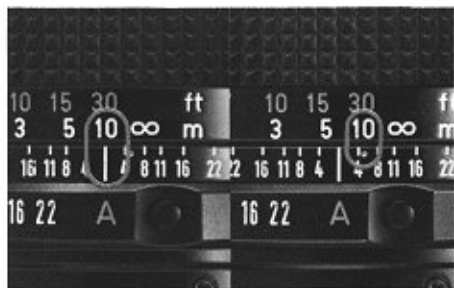

When you load the AE-1 PROGRAM with black-and-white infrared film, it is necessary to make a slight adjustment in focus. A red infrared index is engraved on most Canon lenses for this purpose. First focus as usual through the viewfinder. Then read the distance opposite the distance index on the lens and turn the focusing ring to align that distance with the infrared index. It will also be necessary to use a deep red filter, as specified by the film manufacturer, over the lens. For further details, follow the instructions of the film manufacturer.



24. Shooting in Very Low Temperatures

When you use the AE-1 PROGRAM in temperatures below 0°C (32° F), there are two things you should keep in mind. First, battery power may decrease or fail altogether. Second, extreme temperature changes may damage the camera unless certain precautions are taken.

Try to remember the following:

1. Load a new battery, and keep the camera warm until you are ready to shoot. Try to finish the shooting session as quickly as possible. If you must shoot for a long time, carry a spare battery. Alternate the two batteries, keeping the one that is not in use warm. Do not throw the original battery away. That it does not perform well in the cold does not necessarily mean that it will not work normally again in warmer temperatures. An optional accessory, the Canon External Battery Pack A, is the most reliable power source for uninterrupted shooting in cold weather.
2. Condensation forming on a camera and lens taken from cold outside temperatures into a warm room may cause corrosion. To avoid this, while still outdoors place the camera in a plastic bag. Then seal the bag and take it indoors. Leave the camera in the bag until it gradually reaches room temperature. Generally, this takes about one-half hour.



25. Shooting at Night



In very dim lighting, such as at night, it may be necessary to make an exposure longer than the slowest shutter speed of two seconds. This is what the "B" setting of the shutter speed selector dial is for. When you use this setting, the shutter will remain open as long as you press the shutter button. AE photography is not possible; switch to manual override (page 55). With the lens off the "A" setting, an "M" will light up in the viewfinder when you take a meter reading. The "B" setting is useful whenever it is too dark for metering. It is also the best way to record several bursts of fireworks on a single frame.

Notes

1. The AE-1 PROGRAM's meter will not give a reading at the "B" setting. You will have to experiment to find the best combination of aperture and exposure duration.
2. Always use a tripod and cable release, preferably lockable, for time exposures, and remember that the camera uses more battery power on the "B" setting. We suggest carrying a spare battery as a safeguard.

26. Interchangeable Focusing Screens



You can change the focusing screen in your AE-1 PROGRAM according to your specific focusing needs. Canon offers eight different types of focusing screens for the AE-1 PROGRAM.

* Never change the screen with your fingers. A special tool is provided with each accessory focusing screen to facilitate screen replacement.

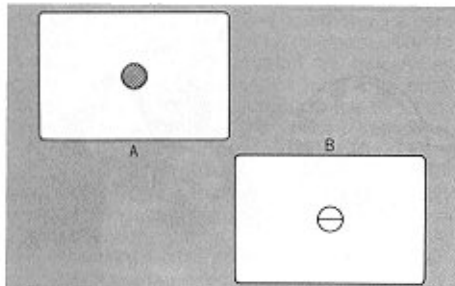

New Split/Microprism

Standard with the AE-1 PROGRAM.

A. Microprism

Matte/Fresnel field with microprism range-finder spot in the center of the screen. Especially suited for general photography when using an aperture of $f/5.6$ or larger.

B. New Split

Matte/Fresnel field with split-image range-finder spot in the center of screen. The lens is in focus when the bottom half is even with the upper half. Suited for general photography since, unlike former focusing screens, rarely does one-half of the rangefinder darken, even when using small maximum aperture lenses.

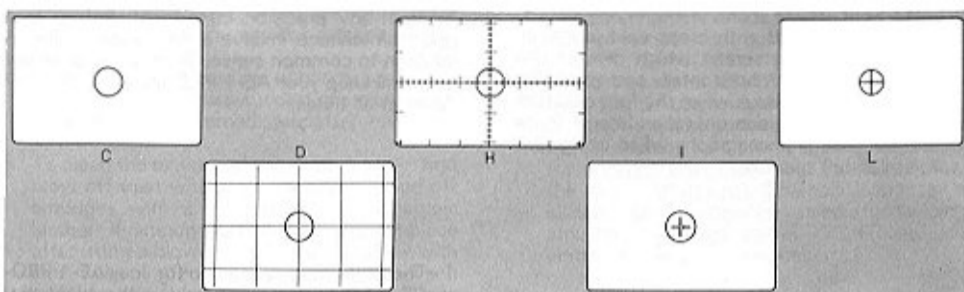

C. All Matte

Matte/Fresnel field with clear matte center spot. Especially recommended for macro and telephoto photography, this screen enables the entire field of view to be seen without distraction. The lens is in focus when the subject can be clearly seen.

D. Matte/Section

Similar to C screen but with horizontal and vertical reference lines. Recommended for architectural photography and copy work in which accurate image placement is essential.

H. Matte/Scale

Matte/Fresnel field with fine matte center plus horizontal and vertical scales in millimeters. Recommended for close-ups, photomacrography, copy work and architectural photography where it is useful to know the size of the subject or the magnification involved.

I. Double Cross-hair Reticle

Matte/Fresnel field with 5mm clear center spot containing double cross-hair reticle. While focusing, move your eye left to right. If cross-hairs stay in the same position on the subject, then the subject is in focus. Recommended for photomicrography, astrophotography, or other applications requiring high magnifications.

27. Caring for your Camera

L. Cross Split-image

Matte/Fresnel field with cross split-image in the center of the screen which divides the subject in half both horizontally and vertically. The subject is in focus when the four quarters merge to become one unbroken image. Suitable for general photography when using fast lenses at full aperture.

As with any precision instrument, proper care and maintenance involve a few simple rules in addition to common sense. Observing these few rules will keep your AE-1 PROGRAM in top condition at all times.

1. The best thing you can do for your AE-1 PROGRAM is to use it regularly. In the event that you must store it for quite a while, first remove it from its case or camera bag. Remove the battery. Wrap the camera in a clean, soft cloth and place it in a cool, dry, dust-free place. If you store the body and lens separately, attach both the body and rear lens caps.
2. Keep the camera and lens out of direct sunlight and away from "hot spots," such as the trunk, rear window shelf or glove compartment of a car. Do not store the camera in a laboratory or other such area where chemicals may cause corrosion.
3. To keep the camera in top condition during prolonged storage, occasionally insert the battery and take several blank shots to "exer-

cise" the mechanisms. Check the operation of each part before you use the camera following long storage.

4. Water, spray, excessive humidity, dust and sand are your camera's worst enemies. Clean it especially well immediately after you use it at the beach.
5. To clean the exterior of the camera body, first blow off dust with a blower brush. Wipe off smudges with a silicone cloth or chamois leather. If smudges remain on the eyepiece after using a blower brush, wipe it lightly with lens cleaning tissue which has been moistened with a couple of drops of lens cleaner.
6. If the lens surfaces are clean, yet the viewfinder appears dusty, the picture will not be affected by the dust in the viewfinder. If the mirror gets dirty, it will not affect pictures but it may make viewing difficult. Dust it VERY gently with a blower brush. If further cleaning is necessary, NEVER do it yourself but take the camera to the nearest authorized Canon service facility.

7. The film chamber needs cleaning from time to time to remove film dust which may scratch the film. Gently dust it out with a blower brush. Be careful NEVER to press on the film rails, shutter curtain and pressure plate.
8. To clean the lens surfaces, use only a blower brush, cleaning fluid and tissue made specially for cleaning camera lenses. Carefully follow the lens' instructions. Chamois leather or a silicone cloth may be used for wiping smudges off the lens barrel—NEVER use such cloths on the glass surfaces!

28. Optional Accessories

CANON A-SERIES SYSTEM ACCESSORIES

Your AE-1 PROGRAM's advanced electronics has enabled Canon to design a number of unique accessories for it. Controlled by the AE-1 PROGRAM's microcomputer, they give unparalleled shooting versatility and handling ease.

Canon Power Winder A2



Attached to the AE-1 PROGRAM, this accessory advances the film, readying the camera for the next shot automatically. Lightweight and compact, the Power Winder A2 is very effective in capturing a subject's movement. Simply set the main switch to "C," hold in the shutter button, and you can shoot at about two frames per second at any shutter speed from 1/60 to 1/1000 sec.; single frame shooting is possible at any shutter speed when the main switch is set to "S." Since the Power Winder A2 is equipped with a socket for remote control, remote controlled shooting is possible with Canon Remote Switch 3 or 60 or the Wireless Controller LC-1.

Note

The Canon Power Winder A can be also used with this camera. Both continuous and single-frame shooting modes are controlled by use of the camera's shutter button. Remote control photography is not possible with this power winder.

Canon Motor Drive MA



This accessory will enhance the versatility of the AE-1 PROGRAM. At the Motor Drive MA's maximum speed, you can shoot continuously at four frames per second. Especially suited for fast-moving subjects, this accessory can freeze action at its peak. Continuous shooting capability at about 3 fps or single frame shooting is possible as well.

A choice of three shutter buttons ensure the utmost in handling ease when shooting in either the horizontal or vertical format. A choice of two power sources, Battery Pack MA and Ni-Cd Pack MA, is available.

Canon Wireless Controller LC-1



This accessory is a remote control photography device using infrared rays to control cameras from a distance. The LC-1 is particularly useful in sports photography, wildlife photography, news coverage, and for numerous other fields.

The Wireless Controller LC-1 consists of a transmitter and a receiver. Up to three cameras can be operated in series when the receivers are set to different channels.

Data Back A



The Data Back replaces the AE-1 PROGRAM's back cover in seconds where it records the date in the lower right-hand corner of the photo automatically at shutter release—or manually afterwards if you wish. You can leave it attached even when you are not using its data recording feature. Date-guessing will become a thing of the past. Since letters of the alphabet and Roman numerals can also be recorded, it is also a convenient coder—a point of particular interest for technical photographers.

Angle Finders A2 and B



There are some subjects which are uncomfortable to view directly through the eye-level viewfinder of the camera. This is particularly true in such fields as close-up photography and photomacrography. In these cases, it might be more convenient to view through an angle finder. Both of these angle finders rotate 90° for viewing from above or from the side.

Angle Finder A2 gives a correct image top-to-bottom, but is reversed left-to-right, while the more sophisticated Angle Finder B gives a completely normal image. Both show the entire field of view and viewfinder information.

29. Other Accessories

Lens Hood



We strongly recommend the use of a lens hood to keep out side light which may cause flare and ghost images to form on the image. Rigid Canon hoods also help to protect the lens from shock. Use only a hood which is specified for your particular lens. Most Canon hoods fit into the bayonet mount and are fixed by turning. For more details, please see the lens' instructions.

Dioptric Adjustment Lenses S

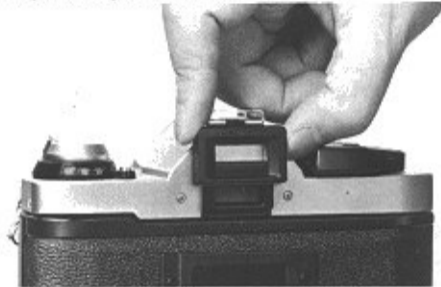

Ten eyesight correction lenses are available in the powers of +3, +2, +1.5, +1, +0.5, 0, -0.5, -2, -3 and -4 diopters. They may make viewing and focusing easier if you are near- or far-sighted. Choose the one which is closest to your eyeglass prescription, and make a practical test if possible.

Magnifier S



The Magnifier S gives a 2.5X magnification of the center of the viewing area for precision focusing in close-up work and wide-angle photography. Its power is adjustable to your eyesight within a range of +4 to -4 diopters. Its adapter is hinged so that the magnifier can be swung upward from the eyepiece, leaving the entire screen image visible.

Filters

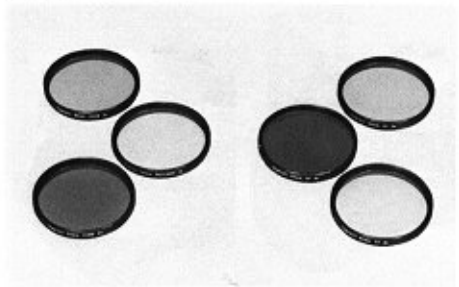

Most Canon lenses accept filters which screw into the front of the lens. Canon offers a wide variety of filters for both color and black-and-white films. A holder for gelatin filters is also available.

A successful picture is a blend of personal vision, a bit of technical know-how and effective use of equipment. Taking a special kind of picture often requires special equipment. Canon offers a complete system of accessories to assist you in your creative pursuits. From our famous line of FD lenses to bellows units and cable releases, we offer just about every accessory you will ever need to take any kind of picture.

Speedlites 133A, 155A, 177A, 188A, 199A, 533G and 577G

For the easiest possible flash photography with the AE-1 PROGRAM, Canon offers seven Speedlites. With an FD lens set to the "A" mark, the shutter speed switches to 1/60 sec. and the aperture to the auto aperture set on the flash automatically when the pilot lamp glows. After shutter release, the camera switches automatically to normal AE photography until the pilot lamp glows again.

Canon's most powerful Speedlites, the 577G and 533G each use a quick-release grip and a separate sensor which, seated in the camera's accessory shoe, ensures correct exposure even when the flash head is tilted or swung. The five A-series Speedlites slide directly into the accessory shoe.

When using any of these Speedlites, a green LED display lights up in the viewfinder of the AE-1

PROGRAM the moment the flash unit is charged. And, when using the Speedlite 188A, which is designed especially for the AE-1 PROGRAM, that same LED display will flash on and off for two seconds after you take a picture to confirm correct exposure. No other flash units offer these features. You can also switch to manual flash photography with five out of these seven Speedlites.

When you are finished using the flash, you can shoot normally while the flash or sensor is still mounted simply by turning off the flash unit's main switch.

With seven units available, you have a wide range of features to choose from. The table on page 81 lists some of the most important.



133A



155A



177A



188A



199A



533G



577G

Speedlite Feature	133A	166A	177A	188A	199A	533G	677G
Guide Number	16m, ASA 100); 26ft., ASA 25)	17m, ASA 100); 28ft., ASA 25)	(w/o Adapter) 25m, ASA 100); 41ft., ASA 25)	(w/o Adapter) 25m, ASA 100); 41ft., ASA 25)	(w/o Adapter) 30m, ASA 100); 50ft., ASA 25)	(w/o Adapter) 36m, ASA 100); 60ft., ASA 25)	(w/o Adapter) 48m, ASA 100); 80ft., ASA 25)
Min. Usable Lens Focal Length	35mm	35mm	35mm; 28mm with Wide Adapter	35mm; 28mm with Wide Adapter	35mm; 24mm with Wide Adapter	35mm; 24 and 20mm with Wide Adapters	35mm; 24 and 20mm with Wide Adapters
Max # of Auto Apertures (Differs with ASA)	1	2	2	2	3	3	3
Auto Shooting Dist. Range, Min. to Max. (Differs with Auto Aperture)	0.5-4m 2-13ft.	0.5-6m 2-20ft.	0.5-9m 2-29ft. less with Wide Adapter	0.5-9m 2-29ft. less with Wide Adapter	0.5-10.6m 2-35ft. less with Wide Adapter	1-12.8m 3.3-42ft. more with Tele-Adapter less with Wide Adapter	1-17m 3.3-56ft. more with Tele Adapter less with Wide Adapter
Bounce	No	No	No	No	Yes	Yes	Yes
Manual Flash	No	Yes	Yes	Yes	Yes	No	Yes

Specifications

Type: 35mm single-lens reflex (SLR) camera with electronically-controlled automatic exposure (AE) and focal-plane shutter.

Exposure Modes: Programmed AE, shutter-speed priority AE, AE flash photography with specified Canon electronic flash units, and manual override.

Format: 24 × 36mm.

Usable Lenses: Canon FD (for full-aperture metering) and Canon FL and non-FD (for stopped-down metering) series lenses.

Standard Lenses: FD 50mm f/1.2, FD 50mm f/1.4, FD 50mm f/1.8

Lens Mount: Canon breech-lock mount

Viewfinder Information: Fixed eye-level pentaprism. Gives 94% vertical and 94% horizontal coverage of the actual picture area with 0.83x magnification at infinity with a standard lens. Information is displayed in form of LED digital display to the right of viewing area. Includes "P" mark (programmed AE and camera shake warning indicator), "M" mark (manual aperture control indicator), aperture display (f/1 — f/32, in full f/stops), flashing warning for overexposure and underexposure, stopped-down metering index, "B" mark (flash charge-completion display with specified Canon flash units and auto-exposure flash confirmation signal with

Speedlite 188A).

Dioptric Adjustment: Built-in eyepiece is adjusted to standard -1 diopter.

Focusing Screen: Standard split-image/microprism rangefinder. Seven other types of interchangeable screens are available optionally.

AE Mechanism: Electronically-controlled, programmed AE and shutter-speed priority AE metering system using one IC and three LSI's with 1^2L .

Light Metering System: Through-the-lens (TTL), Center-Weighted Averaging by silicon photocell (SPC).

Meter Coupling Range: EV 1 (1sec. at f/1.4) to EV 18 (1/1000 sec. at f/16) with ASA/ISO 100 film and f/1.4 speed lens.

Exposure Memory: EV locked in when shutter button is pressed halfway and the AE lock switch is pressed once. Exposure is memorized as long as shutter button is pressed halfway.

Exposure Preview: By pressing shutter button or exposure preview switch.

Shutter: Cloth, focal-plane, 4-spindle, electronically-controlled. With shock and noise absorbers.

Mirror: Instant-return, with shock-absorber.

ASA Film Speed Scale: ASA/ISO 12—3200.

Shutter Speed Selector Dial: 2 sec.—

1/1000 sec., plus "PROGRAM" and "B."
With guard.

Shutter Release Button: Two-step, electromagnetic shutter release button. Also serves as exposure preview switch. With lock, cable release socket, and finger rest.

Main Switch: Three positions: "A," "L," and "S." At "L" all active circuits are cut off as a safety feature. "S" position is for self-timer photography.

Self-timer: Electronically-controlled. Main switch set to "S." Activated by pressing shutter button. Ten-second delay with electronic "beep-beep" sound. Number of beeps emitted per second increases two seconds before shutter release. Cancellation possible.

Stop-down Lever: For depth-of-field preview (FD lens) or metering (non-FD lens or close-up accessories).

Power Source: One 6v alkaline-manganese (Eveready [UCAR] No. A544, IEC 4LR44), silver oxide (Eveready [UCAR] No. 544, IEC 4SR44, Duracell PX 28), or lithium (Duracell PX 28L) battery. Battery lasts about one year under normal use.

Battery Check: "Beep-beep" sound when pressing battery check button. Six or more beeps per second indicate suffi-

cient power; three or fewer beeps per second indicate insufficient power.

Flash Synchronization: X synchronization at 1/60 sec.; M synchronization at 1/30 sec. or slower. Direct contact at accessory shoe for hot-shoe flash. PC socket (JIS-B type) with shock-preventive rim for cord-type flash. Accessory shoe has contact for normal automatic flash plus special contact for AE flash with dedicated Canon Speedlites.

Automatic Flash: Full AE flash photography with specified Canon Speedlites. Shutter speed set automatically. Aperture controlled automatically according to setting of flash when pilot lamp glows.

Back Cover: Opened with rewind knob. Removable. With memo holder.

Film Loading: Via multi-slot take-up spool.

Film Advance Lever: Single-stroke 120° throw with 30° stand-off. Ratchet winding possible.

Frame Counter: Additive type. Automatically resets to "S" upon opening back cover. Counts backwards as film is rewound.

Film Rewind: With rewind button and crank.

Other Safety Devices: Camera will not function when power level insufficient. Film winding impossible while shutter is in operation.

Dimensions: 141mm × 88mm × 47.5mm
(5-9/16" × 3-7/16" × 1-7/8") body
only.

Weight: 575g (20-5/16 ozs.) body only
810g (28-9/16 ozs.) with FD 50mm
f/1.4 lens.

Subject to change without notice.

