



Canon A-1

1	0	0	0	5	6
7	5	0	0	4	5
5	0	0	0	4	0
3	5	0	0	3	5
2	5	0	0	2	8



E

INSTRUCTIONS

INTRODUCTION

Congratulations! You are now the owner of the most exciting and advanced camera on the market. Canon has good reason to have unbounded confidence and pride in the A-1. Embodied in this camera are the qualities of the finest SLR cameras and into it went the most sophisticated electronics technology available in the world today. Incorporating at least 20 novel technologies never before used in a camera, your A-1 is capable of operating in five distinct AE modes—all with an incredibly high degree of precision, reliability and ease of operation. A simple flick of a single switch will put you in any one of the AE modes. Simple manual operation is also possible. With its many AE functions, the A-1 is not only the perfect tool in the hands of a professional but easy enough to operate even for novices. Even the

A-1's system accessories are integrated into its pulse-controlled, digital computer system so that you can enjoy AE flash and motorized AE photography. In the A-1, Canon finally offers you a multifunctional AE camera that actually gives you more creative freedom through more control.

You will find that your A-1 has many unusual features. For the fullest understanding of and benefit from your A-1, please read this instruction booklet carefully as you familiarize yourself with the camera. For the convenience of non-experts, we have included as many photographic hints and facts as space allowed. We at Canon hope your new A-1 will open to you a whole new world of photography, whether as profession or avocation.

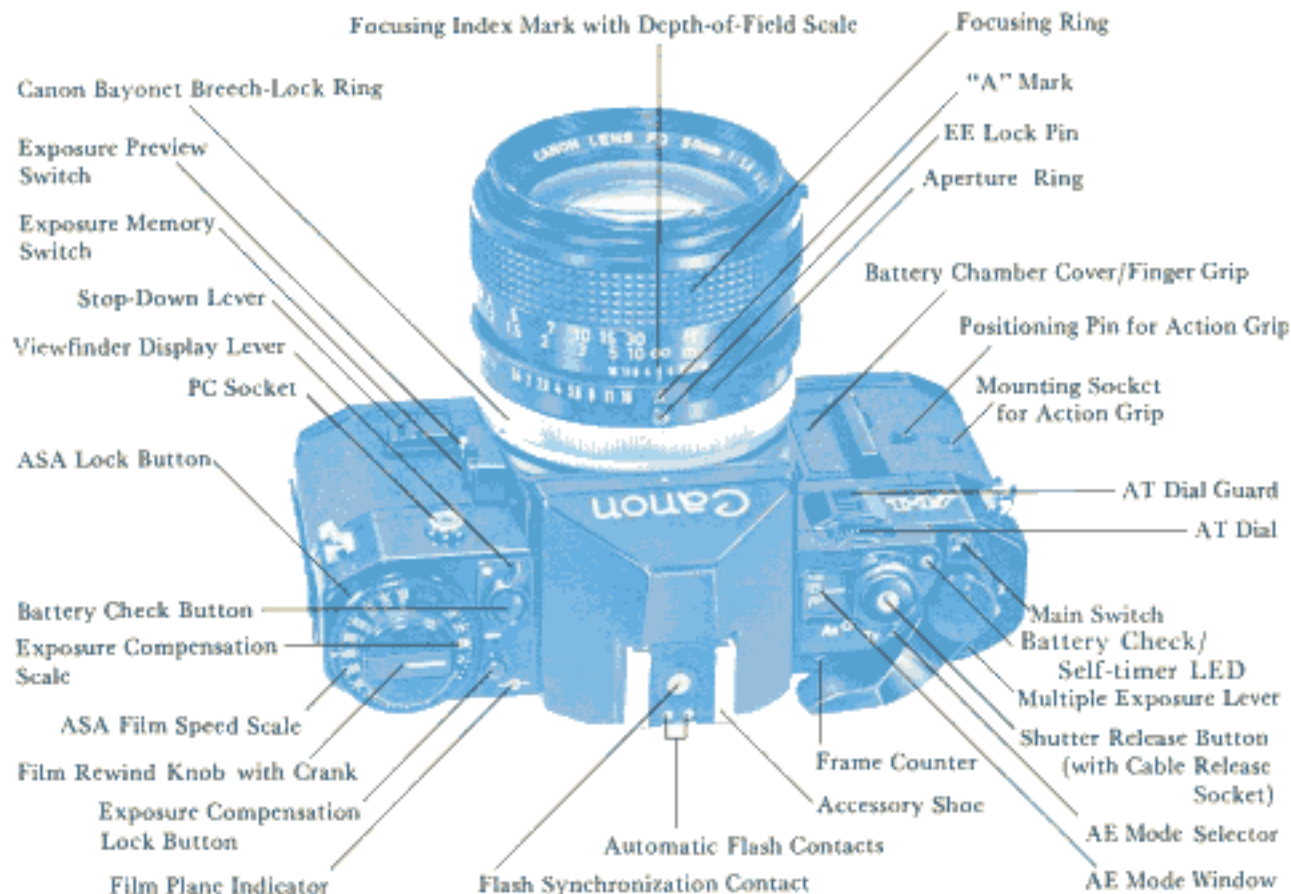

Fold out both front and back nomenclature pages for easy reference while reading the instructions.

TABLE OF CONTENTS

Main Features	7	Numerals and Characters Composing	
Pictorial Outline for General Use of the Camera	10	Digital Readout in Viewfinder	54
Setting the Camera for the Five AE Modes and Manual Override	12	Incorrect Exposure Warnings	55
Preliminary Preparations	14	Double-Check Before Shooting	57
Handling the Lens	16	Shutter Release	58
NORMAL PROCEDURES	18	Rewinding the Film	58
Loading the Battery	19	Frame Counter	59
Checking the Battery	20	SPECIALIZED PROCEDURES	60
Film Advance and Shutter Release	22	Stopped-down AE Photography	61
Holding the Camera	25	Manual Override	65
Loading the Film	26	Self-Timer	66
Setting the ASA Film Speed	28	Exposure Compensation	69
The Basics of Exposure	30	Multiple Exposures	73
AE Photography	32	Film Plane Indicator	75
Setting the Lens for AE Photography	33	Distance Scale	75
AE Mode Selector	34	Infrared Index Mark	75
AT Dial	35	Checking the Depth of Field	76
Shutter Speed Scale on the AT Dial	36	Lens Signal Coupling	78
Aperture Scale on the AT Dial	37	Seeing the Lens in Action	79
Shutter-speed Priority vs. Aperture Priority	40	Automatic Diaphragm Control	80
Programmed AE	45	Manual Diaphragm Control	80
Meter and AE Coupling Ranges	46	Unusable Lenses	81
Metering at Low Light Levels	47	Flash Photography with the A-1	83
Viewfinder	49	Motorized Film Winding	89
Viewing and Focusing	49	Data Back A	90
Optional Viewing Aids	50	Various Accessories for Close-ups and Photomacrography	90
Previewing the Exposure	52	Proper Care of the Camera	95
Cancelling the Viewfinder Display	53	Using the Camera in Extremely Cold Conditions	96
		Specifications	97

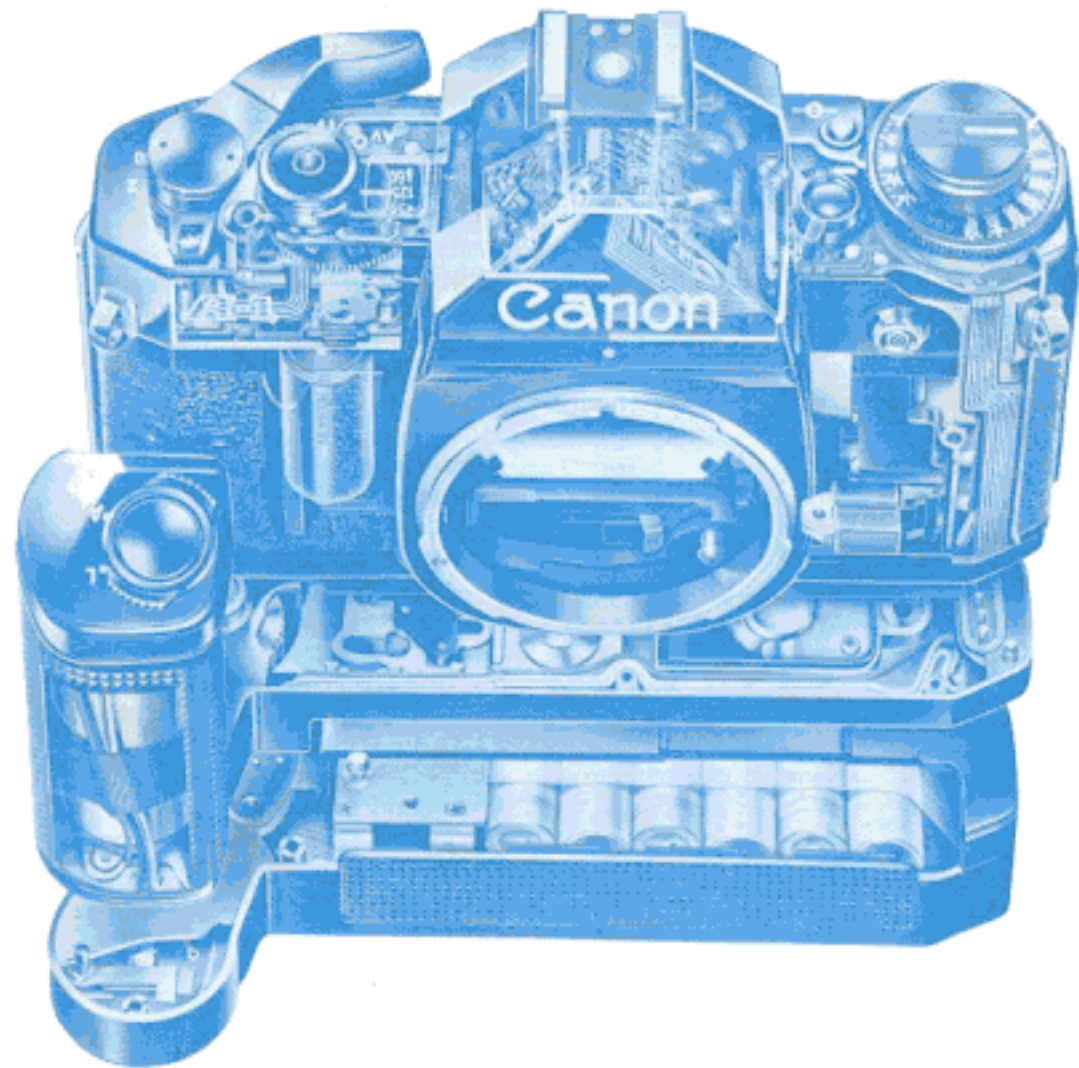

MAIN FEATURES

Quality from the Inside Out

The extraordinary qualities of the A-1 start with its design. It is the first camera in the world in which all information, both input and output, is in the form of pulse signals, enabling it to be the first camera with a digital, rather than an analog, computer. It is the first camera to have a Pure-Integrated Injection Logic (Pure-I²L), the most advanced type of logic circuitry yet produced by the electronics industry, which is so highly integrated that it is capable of processing many times the information possible with simple IC's. It is also the first camera in the world to have a program unit with programmable logic array (PLA) which makes sure that the camera receives all information and in correct order. In practical terms, all of this complex electronics circuitry boils down to the first camera which is capable of extremely precise and reliable automatic exposure in five different modes but which remains remarkably compact and easy to operate.

The use of such advanced technology is not limited to design alone. Building on the special production technology system it established with the design of the AE-1,

Canon has extended its use of computers and automation from automatic production of the main parts to at least partial automation in all facets of production including processing, assembly and inspection. In this contribution to a new system of camera manufacture, Canon is able to offer greater precision at less expense.

Other benefits deriving from the design concept of the A-1 include greatly improved stability against great temperature changes and remarkably improved meter response. The A-1 will set AE exposure only a split second before shutter release.

Despite all of this electronic circuitry which would reasonably require a great deal of power, the A-1 requires only one small battery which normally lasts about one year. Every part of the A-1, from its sequence circuitry, where the power is sequentially switched on and off, to its Pure-I²L and combination magnet, is designed to conserve power.

Five AE Modes and Manual Override

Besides five AE modes which cover all forms of photography, easy override of the A-1's

AE functions is also possible. Shutter-speed priority AE is especially useful in action photography, aperture priority AE in still photography. The programmed AE mode, in which the camera controls both aperture and shutter speed for correct exposure, is good for general use and is the easiest mode for beginners. These three AE modes along with exclusive flash AE, are performed with an FD lens set at "A" for all the benefits of full aperture metering. Stopped-down AE, in which the shutter speed is automatically set, allows automatic exposure with non-FD lenses and accessories and is a big advantage in close-ups and photomicrography. And since all AE inputs have been consolidated into the AE mode selector and the AT dial, the operation of only these two controls suffices to set the camera for any one of the five AE modes.

For complete control for exposure correction or special effects, manual operation is a simple matter of moving the FD lens aperture ring from the "A" mark while the shutter speed is set on the AT dial. The A-1 will even provide you with an exposure readout as a basis for your exposure adjustment.

Exposure Compensation

Along with the wide selection of AE modes,

the A-1 has two controls for wide-range exposure compensation. These are the exposure compensation dial for stepped exposure correction between ± 2 f/stops and an exposure memory switch for temporary correction. For special techniques such as low- and high-key shots, contre-jour photography, multiple exposures and flash photography, you pros will find quick response in the A-1. Even in AE, you have complete control over the image results.

Field-of-view-only Viewfinder

This viewfinder is one of the A-1's most unusual features. In the classic sense of the word, this bright viewfinder shows only the field of view for easiest focusing and composing.

Using any one of three ways to take an exposure preview, you will activate a compact LED digital readout which clearly conveys shutter speed, aperture, flash and manual operation signals, a bulb indication, improper exposure warnings and a malfunction warning. The viewfinder readout is below and out of the way of the field of view, and the LED's are clearly legible with no need for extra illumination even in very bad light.

Wide Metering Range

With its extensive film sensitivity range (ASA 6-12800) and 16 shutter speeds (1/1000-30 sec.), the A-1 offers a wide AE metering range from EV18 (f/16, 1/1000 sec.) all the way down to EV-2 (f/1.4, 8 sec.) with ASA 100 film and an f/1.4 speed lens.

Provided that you can even focus your subject in the viewfinder in a very dark situation, it is most likely that you will be able to meter it as well, even in an AE mode. This is especially advantageous in such dimly-lit situations as those in night scenes and photomacrography.

Other Special Features

Add to these features the A-1's single-lever multiple exposure operation and its two-interval self-timer with an LED warning. Switching one small lever before winding the film sets the A-1 for a multiple exposure. The film and even the frame counter remain stationary for unlimited multiple exposures. You can set the self-timer for a time-lag of either two or ten seconds during which an easily visible LED flashes. Flashing frequency increases as a warning prior to shutter release.

Finally, seemingly small features, but big advantages in photography, include the A-1's

detachable action grip, its 120°-stroke film advance lever with a 30° stand-off, its eyepiece shutter and its shutter button lock (main switch).

The System

Beginning with accessories which are integral parts of the A-1 system, Canon offers the Speedlite 199A and the Motor Drive MA. Either the more powerful Speedlite 199A or the Speedlite 155A can be mounted on the A-1 for AE flash photography with automatic setting of shutter speed and aperture. With the Motor Drive MA, continuous shooting at up to five frames per second is possible, and the A-1 also accepts the Power Winder A. Like the AE-1, the A-1 can also use the Data Back A, a date imprinting mechanism that will couple to both power winder and Speedlite.

Plus, you have your choice of accessories from Canon's extensive SLR system. From its famous, high resolution FD lenses to its complete line of systemized accessories for close-ups, photomacrography and photomicrography, Canon offers high-quality equipment for all photographic fields.



1 Load the battery.

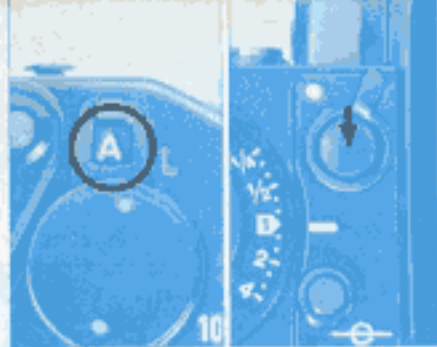

2 Turn the main switch to the "A" position and check the power level.



3 Load the film and advance it to the first frame.

PICTORIAL OUTLINE FOR GENERAL USE OF THE CAMERA

7 Look into the viewfinder.
Compose the picture and focus.

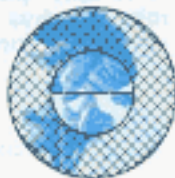

Out of Focus



In Focus

8 Check the exposure.

Flashes to indicate overexposure



2 5 0 5 . 6

Flashes to indicate underexposure





4 Set the ASA film speed.



5 Set the aperture ring of the lens to the "A" mark (for AE photography).



6 Select the AE mode. (Turn the AT dial).

9 Press the shutter button gently.



10 Advance the film to the next frame.



11 Rewind the film after all frames are exposed.

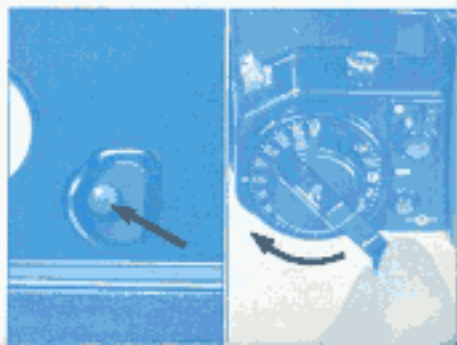



SETTING THE CAMERA FOR THE FIVE AE MODES AND MANUAL OVERRIDE

Shutter-speed Priority AE

1. Make sure the lens aperture ring is set to the "A" mark.
2. Switch the AE mode selector to Tv.
3. Select a shutter speed by turning the AT dial.
See pp. 34-36 for detailed explanation.

Aperture Priority AE

1. Make sure the aperture ring of the lens is set to the "A" mark.
2. Switch the AE mode selector to Av.
3. Select an aperture by turning the AT dial.
See pp. 34-37 for detailed explanation.

Programmed AE

1. Make sure the aperture ring of the lens is set to the "A" mark.
2. Switch the AE mode selector to Tv.
3. Turn the AT dial to "P" at the upper limit of the shutter speed scale.
See p. 45 for detailed explanation.

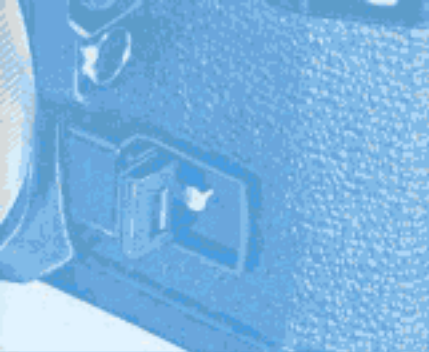

Stopped-down AE

1. Disengage the lens aperture ring from the "A" mark (necessary only on FD lens).
2. Fold and push in the stop-down lever.
3. Set the aperture by turning the lens aperture ring.

See pp. 61-62 for detailed explanation.

AE Flash

1. Insert the Speedlite 199A or 155A into the A-1's accessory shoe.
2. Set the ASA film speed on the flash.
3. Make sure the lens aperture ring is set to "A".
4. Set the auto working aperture on the flash.
5. Switch the flash on.
6. Wait for the pilot lamp to light up and "F" to appear in the viewfinder.
See pp. 83-85 and instruction booklet for Speedlite 199A or 155A for detailed explanation.

Manual Override

1. Disengage the lens aperture ring from the "A" mark (necessary only on FD lens).
2. Switch the AE mode selector to Tv.
3. Select a shutter speed by turning the AT dial.
4. Select an aperture by turning the lens aperture ring (using the camera-selected aperture in the digital read-out as a basis if so desired).
See p. 65 for detailed explanation.



SETTING UP YOUR CAMERA PRELIMINARY PREPARATIONS AND MANUAL OF ENRIDE

Neckstrap

Thread the tips of the strap through the rings. Adjust the neckstrap to the length most comfortable for you.

Plastic Insert

Pull up the film rewind knob and open the camera's back cover. Remove the plastic insert which is designed to protect a new camera while in transport and snap the back cover shut. The insert is no longer necessary and may be thrown away.

Eyecup 4S

This is an accessory eyecup which snaps into the eyepiece grooves. Its use is not mandatory, but viewing with it may be more comfortable, and it helps block extraneous light from entering the viewfinder.



Action Grip

The A-1 has a handy, built-in finger grip, but to make camera holding all the easier, it comes with a detachable action grip as well. Before attaching the grip, load the battery into the camera. Then, using a coin, screw the grip into the action grip mounting socket guided by the positioning pin on the front of the camera body.



Semi-hard Case

To protect the camera, particularly when carrying it, insert it into its semi-hard case. The screw in the bottom of the case screws into the camera's tripod socket. You can easily shoot pictures even with the camera in the semi-hard case by removing the top cover. To do this, turn the top cover to the bottom, slide it straight up in the direction of the arrow and pull it out as indicated in the photo.

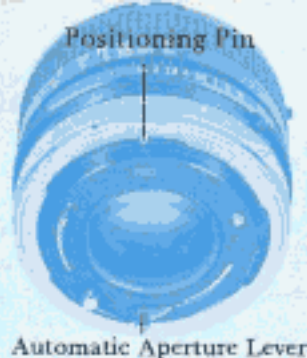

HANDLING THE LENS

Lens Cap and Rear Dust Cap

The lens is provided with protective caps for both front and rear. Both should always be attached when the lens is not in use.

To remove the rear dust cap, rotate the bayonet ring clockwise until it stops. The red dot on the bayonet ring will be aligned with the positioning pin at the rear of the lens. When the rear dust cap is removed, the bayonet ring is locked as a safety measure and cannot be turned in either direction. The rear dust cap can be re-mounted by aligning its slot with the positioning pin and, pressing gently on the cap, turning the bayonet ring counter-clockwise.

The front lens cap hooks into the lens filter threads. It can also be attached to a double-screw type filter screwed into the lens. It is easily attached and removed by pressing in

the tabs on both sides of the cap. As a precautionary measure, please keep the lens capped when not shooting. If the camera were to be placed lens-up with the lens uncapped in direct sunlight, for instance, the film might fog and the shutter curtain could be burned.

Hood

The lens hood is an optional accessory which is very useful in preventing ghost images and flare. To mount a hood, fit it into the bayonet mount at the front of the lens and turn it until it is tight. When not in use, the hood can be mounted in reverse on a standard or some wide-angle lenses, which enables both lens and hood to fit perfectly into the camera's soft case.

Mounting Procedure

First make sure that the camera's stop-down lever is not locked in (if locked in, a red dot



will appear beside the coupling lever inside the camera mount). Check that the automatic aperture lever at the rear of the lens is in its unlocked, automatic position (see p.80). Do not mount an FD lens when the film is only partially advanced.

1. Pull the body cap off the front of the camera.
2. Remove the lens' rear dust cap.
3. Make sure the bayonet ring is properly locked into position with the red dot on the ring aligned with the positioning pin at the rear of the lens. It will not mount onto the camera otherwise.
4. Align the red dot of the bayonet ring with the red dot on the front of the camera body just below the manufacturer's signature on the pentaprism.
5. In this position, fit the rear of the lens into the camera body and turn the bayonet ring clockwise until it is tight.

6. To dismount the lens, turn the bayonet ring counterclockwise until it stops and pull the lens out from the camera body. When changing lenses, you should take special care not to damage the protruding levers and pins on the rear. With the exception of the Fish-eye 7.5mm lens, always put down a lens with the rear facing up.

Whenever you mount an FD lens on the A-1, its maximum aperture is automatically transmitted to the camera's AE circuit. Even if you switch to an FD lens of a different maximum aperture, the mounting procedure is the same as that described above and requires no adjustment.

All five AE modes are possible with an FD lens. See SETTING THE LENS FOR AE PHOTOGRAPHY. Of the five AE modes, only stopped-down AE is possible with an FL lens.

Normal Procedures



Loading the Battery

This camera will not function unless a battery is loaded. Use one brand-new silver oxide or alkaline-manganese battery as specified in the table below or an equivalent battery of another brand.

Usable Batteries	
Silver Oxide Battery (6V)	Eveready (UCAR) No. 544 JIS 4G13 Mallory PX 28
Alkaline-manganese Battery (6V)	Eveready (UCAR) No. 537

It can be loaded and unloaded more easily before the lens is mounted, and, of course, if the action grip is attached, it must be removed while loading. You should always wipe the battery poles with a clean, dry cloth before insertion to prevent any cor-

rosion and damage to the camera due to dirt or fingerprints.

To load the battery:

1. Apply either a fingernail or the eyepiece protective cover, which is inserted into the accessory shoe of the camera, into the groove of the battery chamber cover and lift lightly so that the cover flips up.
2. Following the diagram on the inside of the battery chamber, load the battery negative pole first, pushing it downwards in the chamber. Make sure the poles are facing in the correct directions. Incorrect loading can lead to possible corrosion and damage to the battery terminals besides causing the battery to discharge very quickly.

To unload the battery, simply tip the positive end forwards and pull it out from the top. The battery should be removed if the camera is not to be used for an excessively long period of time.



Checking the Battery

Life of the battery in normal use is approximately one year. Using the camera frequently at low shutter speeds, at the "B" setting or in extremely cold conditions takes more battery power and requires replacing the battery more often.

The battery requires checking under the following circumstances:

1. When a new battery is loaded.
2. If the shutter will not function when the main switch is at "A".
3. When long exposures are frequently made.
4. When the camera is used very frequently.
5. When the camera is used after it has been stored for an excessively long period of time.
6. When the camera is used in extremely cold conditions.

To check the power level of the battery, first set the main switch to the "A" position. It

cannot be checked in the "L" position. Then press the battery check button on the top of the camera for two to three seconds. If, while pressing the battery check button, the LED on the top of the camera blinks on and off rapidly, battery power is sufficient. If it blinks only slowly, twice per second, for instance, or not at all, the power level is insufficient and the battery should be replaced. It should also be replaced if the flashing frequency changes during the few seconds the check button is depressed, indicating the battery is near exhaustion.

It is a good idea to carry a spare battery when you expect to use the camera continuously for a long time, such as on a vacation, when you plan to take a number of time exposures on bulb, or when the camera is to be used in very cold conditions.



The battery check button also serves to cancel the self-timer or to cancel the shutter in long exposures. The circuit is cancelled the moment you press the button, and the second shutter curtain will close when your finger is removed from the button. The shutter will not be released if you press the shutter button while pressing the battery check button.

Getting a Feel for Your A-1

Now that the battery is loaded, your A-1 will function. Before loading the film or doing anything else, play with it a little. Operate the shutter button and the film advance lever until they feel like natural extensions of your fingers.

Shoot and develop at least one roll of film with a new camera before using it on a shooting expedition or on a trip to make sure you know how to operate it properly and that everything is in proper operation.



Film Advance and Shutter Release

At the base of the film advance lever is the main switch of the camera. When it is at the "L" (LOCK) setting, all active circuits are turned off and the shutter button is locked to prevent unintentional shutter release. This switch should always be in the "L" position to prevent battery consumption and film wastage when the camera is not in use, such as when it is in a camera case.

When the main switch is set at "A", the shutter button can be operated. The shutter button serves to activate both the AE meter and shutter operation. Since it is electromagnetic, it requires only gentle pressure for both a very smooth shutter release as well as immediate meter response when shooting in quick succession. Pressing the shutter button lightly only halfway gives a meter reading preview inside the viewfinder. When you press it gently all the way, the mirror flips up, the diaphragm closes down and the

shutter releases. After shutter release, the mirror and diaphragm automatically reset and the film advance lever is ready to be advanced.

With the tip of your thumb, lightly push the film advance lever away from the camera body to its 30° stand-off position. Now it can be easily operated with the tip of your thumb. Push it all the way to the right in a single, short 120° throw to wind the film, cock the shutter and prepare the diaphragm and mirror for the next shutter release all in one motion. Or you can advance the lever in several short strokes. Each winding will also advance the number in the frame counter, indicating the number of pictures taken.



Attaching a Cable Release

A cable release is a device which, used in conjunction with a tripod, allows the shutter to be held open for long exposures without your ever having to touch either camera or shutter button directly. This is especially useful for reducing the chances of blurred images in copy work, photomacrography and photomicrography.

The A-1 is provided with a socket for a cable release in the center of the shutter button. The cable release simply screws into this socket. The main switch must also be at the "A" setting.



Holding the Camera

The best precaution in preventing camera shake is to press the shutter button gently. Never punch it. It is also helpful to hold the camera properly, not only for good image results but also for comfort and ease in handling.

We suggest first that you hold the camera firmly in both hands, the tip of your right thumb on the film advance lever, the right index finger on the shutter button and the other right fingers on the finger grip. For best balance and easy focusing, the left thumb and index finger should be under the lens barrel. Press both elbows firmly against your body when holding the camera in a horizontal position, at least one elbow in a vertical position. Press the camera firmly to your cheek or forehead. Spread your feet slightly apart with one a little ahead of the other. Don't tense up. Now release the shutter button gently as you exhale.

It is always advisable to lean against a steady support, such as a wall or a tree, if any is available. Use a tripod and a cable release with a telephoto lens or when shooting at a shutter speed of 1/30 sec. or slower.

If the tripod screw of your tripod is quite long, be especially careful not to forcefully screw it all the way in beyond the limit of the camera's tripod socket.

Since this is a single-lens reflex camera, the viewing lens and the camera lens are not separate. When you look into the camera's viewfinder, you are seeing your subject through the lens exactly as the lens "sees" it and exactly as it will be exposed. There is no need to be concerned with parallax.



Film Loading

The Canon A-1 accepts color or black and white film in standard 35mm cartridges. When loading and unloading film, avoid direct sunlight and take care not to touch the shutter curtain, the film rails or the pressure plate.

To load the film, first fold out the rewind crank and sharply pull up the rewind knob. The camera's back cover will pop open. Put the cartridge into the film cartridge chamber so that the protruding part of the spool is on the bottom and push down and rotate the rewind knob until it drops into its fully-seated position. Now pull the film leader across the camera and insert the tip up to at least the first perforation of the film into any slot of the multi-slot take-up spool. Advance the film once, making sure the film sprocket holes are engaged with the teeth of the film transport sprocket.

Check to see that the cartridge is in a fully-seated position and that the film is taut. If there is film slack, gently turn the rewind crank clockwise until it stops. Snap the back cover shut. Gently turn the rewind crank in the direction of the arrow to take up film slack and then fold the rewind crank back in.

Switch the AE mode selector to Tv and turn the AT dial to a fast shutter speed. Now make two blank shots, turning the film advance lever and releasing the shutter, so that the frame counter advances from "S" to "0". While doing this, keep an eye on the rewind knob. If it rotates, the film is properly loaded. If it does not rotate, chances are that the film is sagging or the film perforations are not properly engaged in the take-up spool and film transport sprocket. If the rewind knob still does not rotate once you have gently turned the

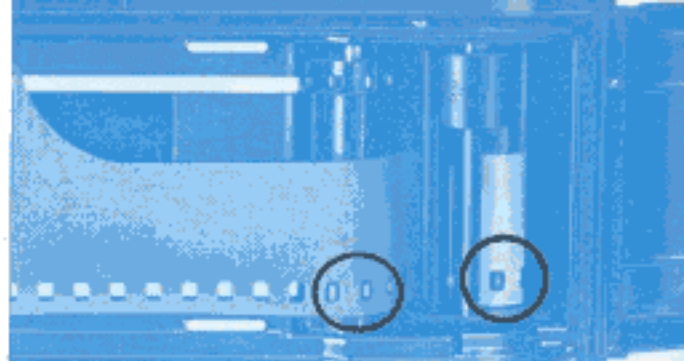
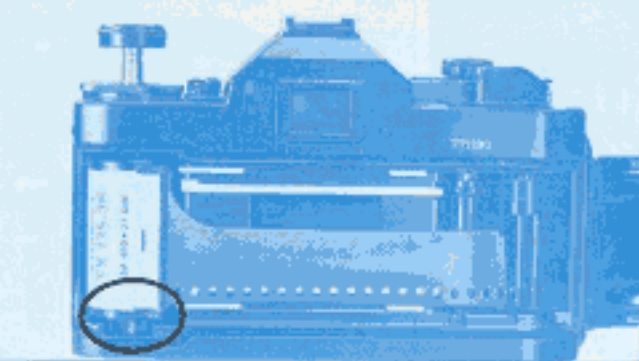

rewind crank clockwise to take up film slack, open the back cover and reload the film.

The A-1 can also be loaded with bulk film in which case the tip of the film should be trimmed as illustrated below before it is loaded into the camera.

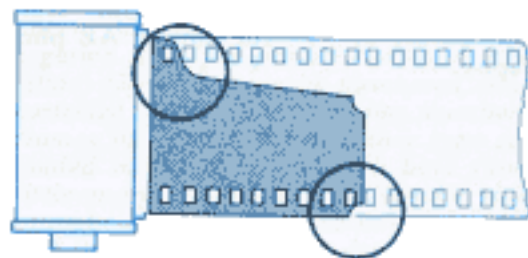

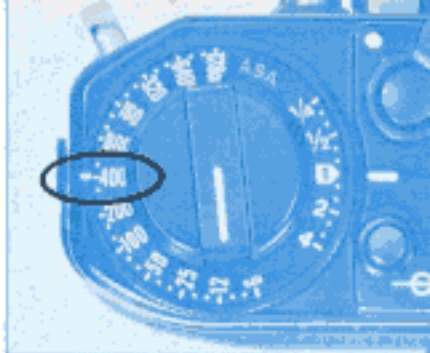

Setting the ASA Film Speed

The ASA is a numerical rating of a film's sensitivity to light. The higher the ASA rating, the faster the film and the more sensitive it is to a given amount of light as compared to a film of a lower ASA rating. In other words, the higher the ASA rating, the less light you need to expose the film. When buying film, choose one with an ASA rating appropriate for the lighting conditions. The film manufacturer's recommended ASA rating can be found on the film packaging or data sheet.

Since the ASA film speed is one of the essential factors in determining proper exposure, it is very important that it be correctly set on the camera. The table on the opposite page shows the ASA ratings which can be set on the A-1. Figures in parentheses are intermediate film speeds which are indicated by dots on the ASA dial. To set the

ASA, press in the ASA film speed dial lock button with your fingernail and turn the outer knurled edge of the dial until the desired film speed rating is aligned with the film speed index. The dial cannot be turned lower than ASA 6 or higher than ASA 12800.

There is an exposure compensation scale on the ASA film speed setting dial. The function of this scale will be explained later, but at this point, please note that this scale should be set at "1" for normal AE photography.

ASA	6	•	•	12	•	•	25	•	•	50	•	•	100	•	•	200	•	•	400	•
	(8)	(10)		(16)	(20)		(32)	(40)		(64)	(80)		(125)	(160)		(250)	(320)		(500)	
	•	800	•	•	1600	•	•	3200	•	•	6400	•	•	12800						
	(650)		(1000)	(1250)		(2000)	(2500)		(4000)	(5000)		(8000)	(10000)							

The choice of film is an important part of photography, and you have a wide variety to choose from. Films differ in a number of ways including ASA rating, exposure latitude, color rendition and color temperature among other variables. Some, such as infrared film, require the use of certain filters. Depending on the type of film, a color temperature conversion filter may be necessary under certain lighting conditions. And, of course, you have the basic choice between two types of color film: color negative film (for prints) and color reversal (slide) film. Film can be purchased either in cartridge form with varying numbers of frames or in bulk form. Either type can be loaded in the A-1. Although bulk film is a little more complicated to handle since it must be cut to the desired number of frames and handled in complete darkness, there are simple devices for this purpose on the

market and it is cheaper than cartridge film. For more information concerning film, please refer to a book on photography or ask your local film dealer, and please pay careful attention to the film data sheet.

Aside from those instances when a specific filter is required, filters can also be used to emphasize certain colors for more clarity or special effects. Canon offers a wide variety of filters for both black and white and color films. It also offers a gelatin filter holder which can hold up to three filters at a time and can be attached to various diameter lenses by means of adapters. Since the A-1 has a through-the-lens meter, there is no need to make any exposure correction with filter factors when a filter is attached.

Kodak Tri-X pan

36 EXPOSURES

TX 135-36



Memo Holder

The back cover of this camera is provided with a memo holder. Once you have loaded the film and set the ASA, it is very useful to tear off the end of the film box and insert it into this memo holder as a constant reminder of the type of film in use. Add other information as you like.

The Basics of Exposure

This section contains some terms and definitions which will be used throughout this instruction booklet.

The amount of exposure is a matter not only of the amount of light allowed to strike the film but also of the amount of time the light is allowed to strike the film. The camera has two mechanisms to control exposure, the diaphragm and the shutter. The diaphragm consists of blades which open and close to certain size openings called apertures. The size of the aperture determines the amount of light which will fall on the film. The various size apertures are indicated by a set series of numbers called *f/stops* or *f/numbers*. Each *f/stop* represents some amount of light that is allowed to pass through the lens. The smaller numbers are called large *f/stops* while the larger numbers are called small *f/stops*. This is because the larger numbers represent smaller apertures and allow less light to pass



through the lens. Each time you move from one *f*/stop to the next smaller *f*/stop (larger number), the amount of light allowed through is exactly halved. In effect, the amount of exposure itself is also halved. Using *f*/2 as a standard, the amount of light reaching the film will change according to *f*/stop as indicated below:

On the A-1, aperture can be controlled either by turning the AT dial or the lens aperture ring to the desired *f*/stop. Otherwise the camera controls the aperture.

The largest *f*/stop on the lens is called the lens maximum aperture. The smallest *f*/stop on the lens is called the lens minimum aperture. The maximum and minimum apertures differ according to the lens. The maximum lens aperture is important because it indicates the largest amount of light that the lens will transmit. Sometimes the maximum aperture is a half-*f*/stop rather than a full *f*/stop on the aperture scale.

<i>f</i> /stop	1.2	1.4	1.8	2	2.8	3.5	4	5.6	8	11	16	22
Brightness ratio	3	2	1½	1	½	⅓	¼	⅓	⅕	⅓	¼	⅕

*Half *f*/stops.

The length of time that the light is allowed to strike the film is determined by the shutter speed. The relationship between shutter speeds is like that between f/stops. As you move from one shutter speed to the next higher shutter speed, exposure is halved. Your image is actually exposed by the opening of the shutter. Shutter speed can be controlled on the A-1 by turning the AT dial. Otherwise the camera controls it.

Now suppose that you have the camera set for a certain exposure value (EV), say the exposure you get with f/4 at 1/60 sec. There are certain other combinations of aperture and shutter speed which will give you the same amount of exposure as that above. Some of these combinations in this example include f/5.6 at 1/30 sec, and f/2.8 at 1/125 sec. You simply move up and down the f/number and shutter speed scales. It is not important to know this relationship when you use the A-1 in an AE mode. The camera will do the figuring for you. But it is an important photographic fact which you may find useful when you use the camera manually or in correcting exposure.

AE Photography

AE photography means automatic exposure. The camera is selecting either shutter speed or aperture or both for you.

The most obvious, unusual feature of this camera is the absence of the shutter speed dial which has been replaced by the AT dial. This dial allows you to set either shutter speed or aperture for any of five different AE modes.

Through-the-lens full-aperture metering

Shutter-speed priority AE

Aperture priority AE

Programmed AE

AE flash photography

Through-the-lens stopped-down metering

Stopped-down AE

In shutter-speed priority AE, you set the shutter speed, and the camera automatically selects the necessary aperture according to lighting conditions for correct exposure. Shutter-speed priority AE is applicable to most subjects but especially useful in action photography.

In aperture priority AE, you set the aperture while the camera automatically selects the necessary shutter speed for correct exposure. It is convenient for the various forms of still photography in which depth of field is of importance.

The camera automatically selects both



Instead of an "A" mark, some earlier FD lenses have a small green circle on the aperture ring for AE photography. Its use is the same as that of the "A" mark, and the procedure is the same as that described above except that some of these lenses may not have an EE lock pin for locking the aperture ring at the automatic setting.

AE Mode Selector

The AE mode selector has two possible settings, Tv (time value) and Av (aperture value). When the AE mode selector is switched to Tv, the camera is set for the shutter-speed priority AE mode. You set the shutter speed and the camera selects the aperture. When switched to Av, the camera is set for aperture priority. Here you set the aperture, and the camera automatically selects the shutter speed.

The AE mode selector click stops at for Tv and at for Av.



AT Dial

This dial works in conjunction with the AE selector. When the AE selector is set at Tv, it shows the shutter speed scale. When the AE selector is set to Av, it shows the aperture scale.

To operate the AT dial, first slide down the AT dial guard which is designed to prevent accidental movement of the dial. Depending on the setting of the AE selector, turn the AT dial until it click stops at the exact aperture or shutter speed desired so that the setting is aligned with the index mark. The AT dial will not turn past the highest and lowest limits of each scale.

The figure set on the AT dial has priority in determining the exposure. If, for example, you have set a shutter speed on the dial, the camera balances the aperture against the shutter speed you have selected until exposure is correct.



If, on the other hand, you have set an aperture on the dial, the camera selects the necessary shutter speed for correct exposure.



Shutter Speed Scale on the AT Dial

There is a choice of 16 click-stop settings ranging from 1/1000 (sec.) to 30 (sec.) on the AT dial's shutter speed scale. The slow shutter speeds from 2 (sec.) to 30 (sec.) are marked in orange while shutter speeds from 1 (sec.) to 1/1000 (sec.) are in white. The white numbers on the scale are the reciprocals of the true shutter speeds so that a white 2 indicates a speed of 1/2 sec. while a white 1000 indicates a speed of 1/1000 sec. Be careful not to confuse the slower orange range with the faster white range.

Above the highest speed of 1/1000 is the "P" for programmed AE. Below the lowest speed of 30 is the "B" setting. The dial will not turn past the "P" or the "B".

The "B" (Bulb) setting is intended for exposures longer than 30 sec. When the shutter speed is set at "B", the shutter will remain open as long as you press the shutter

button. AE photography is not possible at the "B" setting. The aperture must be set manually. Remember that it is very important to use a tripod and a cable release, preferably with a lock, in long exposures to reduce the chance of image blur. Also, since long exposures present a real drain on the battery, it may be wise to carry a spare.

The A-1 has a hot shoe and PC outlet for an X-synch (flash synchronization) at 1/60 sec. (the $\frac{1}{2}$ position). This shutter speed need not be considered, however, when the A-1 is used with specified Canon flash units (see page 83).

Intermediate settings on the shutter speed scale cannot be used. However, if you accidentally set an intermediate shutter speed, the camera will automatically select the next lower or higher shutter speed as the effective shutter speed, and that shutter speed will be displayed when you take an exposure preview.

If you mistakenly try a time exposure on "bulb" while the lens is still at "A", exposure will take place at the lens minimum aperture.



Aperture Scale on the AT Dial

The aperture scale on the AT dial is calibrated in *f*/stops ranging from *f*/22 to *f*/1.2. The *f*/1.2 setting is indicated by a dot. The dial click-stops at both full and half *f*/stops. It will not turn past the largest and smallest *f*/stops. The maximum aperture indicated on the AT dial is large enough for any Canon lens.

Under certain conditions in the aperture priority AE mode, the maximum and minimum apertures on the lens have priority over the aperture set on the AT dial. For instance, if the aperture you have set on the AT dial is larger than the maximum aperture of the lens in use, the camera will match the shutter speed to the lens maximum aperture rather than the aperture you have set on the AT dial for correct exposure. Thus, if you are using an FD 50mm *f*/1.8 S.C. lens with the AT dial set to *f*/1.4, the camera will use

f/1.8 as the aperture setting. In this case, the maximum aperture of the lens will be displayed in the viewfinder when you take an exposure preview regardless of the setting on the AT dial. On the other hand, if you have set an aperture on the AT dial smaller than the minimum aperture of the lens, the image will be exposed at the lens minimum aperture but the shutter speed will not be adjusted accordingly, resulting in over-exposure. In this case, the aperture set on the AT dial will be displayed in the digital read-out.

Since the smallest aperture that can be set on the AT dial is *f*/22, if you want to set an aperture smaller than *f*/22, switch to stopped-down AE and manually set the aperture on the lens aperture ring.

Shutter-Speed Priority vs. Aperture Priority

Having now read how to control the camera for shutter-speed priority and aperture priority AE photography, you might well wonder when it is best to use which mode. Basically, it depends upon what you want your photograph to portray.

Shutter speeds are most effectively used to freeze or emphasize movement. The shutter-speed priority AE mode is applicable to most photographic situations.

Aperture priority is most applicable to still photography such as portraiture and landscape photography in which depth of field is an important factor. Some of the best creative commercial and architectural photographs are taken in the aperture priority AE mode. This, however, does not apply to such fields of photography as close-ups and photomicrography for which you should refer to the section entitled STOPPED-DOWN AE.

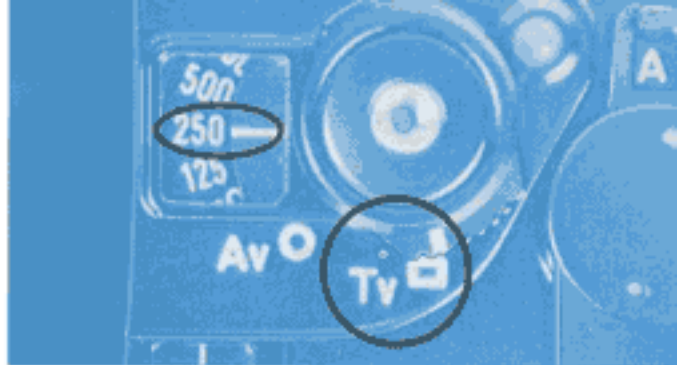

Selecting a Shutter Speed

The table below can be used as a general guide in selecting an appropriate shutter speed according to lighting conditions when using a standard 50mm lens and 100 ASA film.

Brightness	Shutter Speed (Seconds)
Indoors	1/30 to 1/60
Outdoors	1/125 to 1/250
Mid-summer Beach or Snow-covered Mountains	1/500 to 1/1000

This table does not necessarily apply when using a lens of a different focal length. If you are using a telephoto lens, for instance, any subject movement and the least bit of camera shake can have a magnified effect on image sharpness. For a telephoto it is necessary to use faster shutter speeds than with a standard lens under the same lighting conditions. It is generally said that, for sharp image results in hand-held shooting, the minimum shutter speed should be equal to or faster than 1 divided by the focal length of the lens. This means that for a 100mm lens, the shutter speed should be at least 1/125 sec.; for a 200mm lens, it should be at least 1/250 sec.

There are other considerations in the selection of shutter speed. You can usually freeze the action of relatively slowly moving pedestrians or traffic at a shutter speed of 1/250 sec. The same is not necessarily true of a rapidly moving bicycle. Instead of freezing the action, you may want to emphasize it by blurring some part of the picture. For instance, you could blur a moving subject with a relatively slow shutter speed. Or, using a panning technique, turning the upper part of your body to follow the subject's movement, at a relatively slow shutter speed of perhaps 1/30 sec., you can

blur the background to stress the movement. In this last technique, it is best to continue panning as you release the shutter.

The direction of movement should also be considered. A subject moving directly across in front of the camera will be blurred to a greater degree than a subject which is moving diagonally across or is heading straight for or away from the camera and may require faster shutter speeds than you would use considering speed of movement alone.

In fashion photography, a rapid succession of shots at fast shutter speeds, or using a flash while the model continuously changes the pose, helps to capture natural expression.

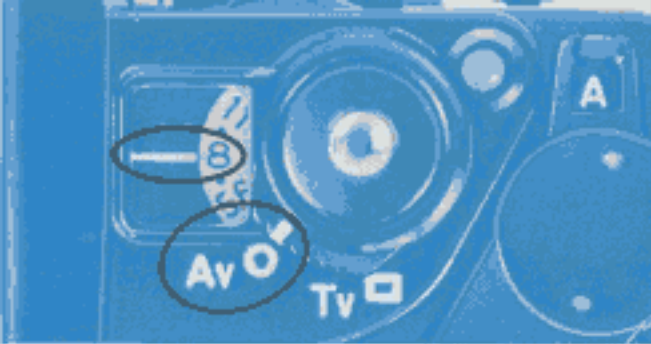

Selecting an Aperture

A discussion of how to select an appropriate aperture boils down to an explanation of depth of field. When your subject is in focus, there is only a limited range in the foreground and background of the subject which is also in focus. This zone of sharpness is called depth of field.

Depth of field is governed by three factors: aperture, lens focal length and shooting distance. Remember the following relationships:

- (1) The smaller the aperture, the deeper the depth of field (the other two factors remaining the same).
For example, if the lens focal length and the shooting distance stay the same, the depth of field is much deeper at $f/16$ than at $f/1.4$.
- (2) The shorter the lens focal length, the deeper the depth of field (the other two

factors remaining the same).

For example, comparing a 28mm lens with a 50mm lens at the same aperture and shooting distance, depth of field is deeper with the 28mm lens.

- (3) The greater the shooting distance, the deeper the depth of field (the other two factors remaining the same).
For example, if the subject is photographed from three and then from seven meters away, the zone of sharpness in the foreground and background is greater at seven meters.

Another characteristic of depth of field is that it is generally deeper in the background than in the foreground.

When depth of field is important in your picture, it is best to control the aperture directly using the aperture priority AE mode. Using a small aperture is great for getting sharp overall focus in a landscape or any other type of subject, but shallow depth of field also has its merits. Using a relatively large aperture will make your subject stand out against its surroundings by blurring the background. This is an especially successful technique in portraiture and special effects.

There are ways to check the extent of depth of field. For this information, please refer to page 76.



the aperture for correct exposure. Of course, if it shifts to a shutter speed lower than 1/60 sec., it is advisable to use a tripod and a cable release or to switch to flash photography.

The advantage of this particular mode is that it takes your mind completely off exposure so that you can concentrate on your subject,

Programmed AE

When the AE mode selector is set to Tv and the AT dial turned to "P" on the shutter speed scale, the camera is set for programmed AE. Correct exposure, both aperture and shutter speed, is automatically set by the camera according to the brightness of the subject and a programmed set of combinations of apertures and shutter speeds. Metering control is done steplessly from a combination of the highest shutter speed and minimum aperture all the way to slower shutter speeds and larger apertures.

Under some circumstances, the camera behaves as if it were set for aperture priority AE. For example, if lighting conditions are so low that an aperture larger than the maximum aperture of the lens would be necessary, the maximum aperture remains fixed, and the camera's electronic control automatically shifts to slower shutter speeds until the shutter speed is balanced against

Programmed Combinations of Shutter Speed and Aperture in Programmed AE (with ASA 100 film)

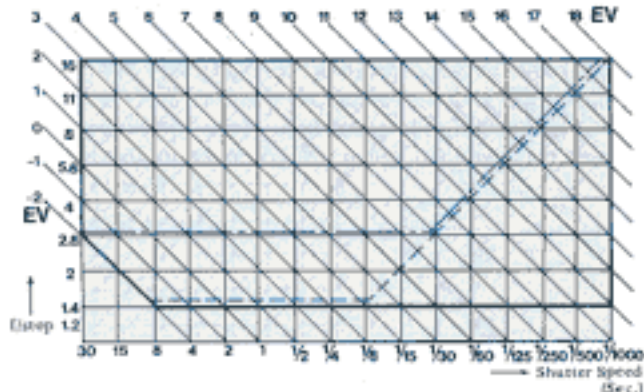

----- indicates programmed combinations when a lens with a maximum aperture of f/2.8 is used.

..... indicates programmed combinations when a lens with a maximum aperture of f/1.4 is used.

**AE Range of Silicon Photocell at Various ASAs
FD 50mm f/1.4 S.S.C. Lens**

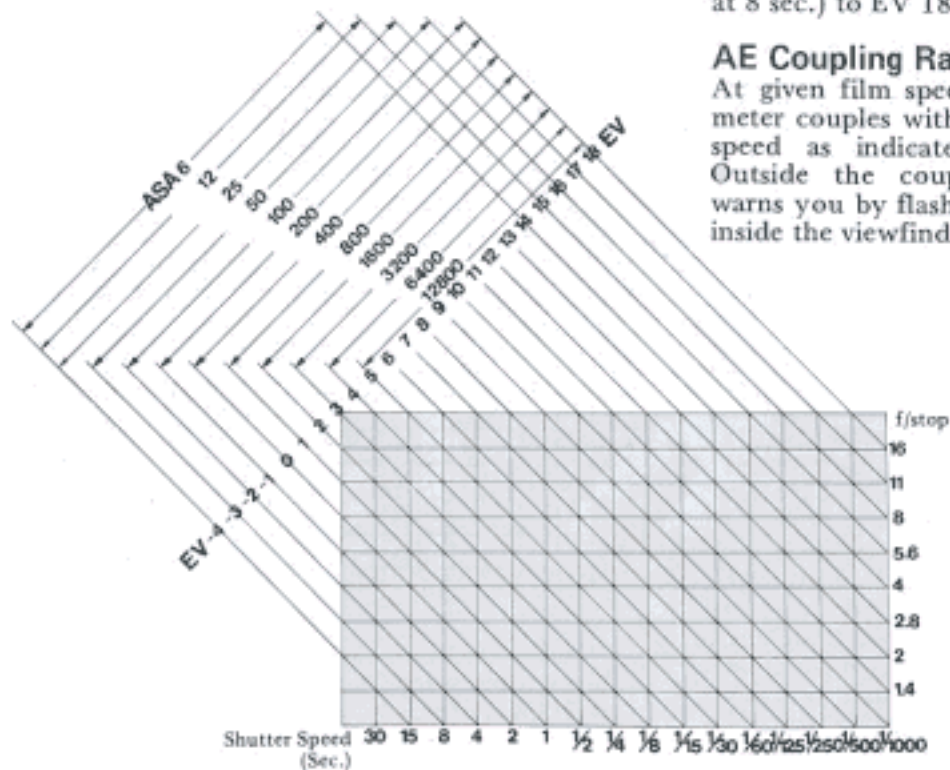

Meter Coupling Range

When using the FD 50mm f/1.4 S.S.C. lens and ASA 100 film, the built-in exposure meter couples within a range of EV -2 (f/1.4 at 8 sec.) to EV 18 (f/16 at 1/1000 sec.)

AE Coupling Range

At given film speeds, the built-in exposure meter couples with the aperture and shutter speed as indicated in the chart below. Outside the coupling range, the camera warns you by flashing the photographic data inside the viewfinder.

Metering at Low Light Levels

With AE coupling all the way down to EV -2 (with ASA 100 film), the A-1 is capable of metering and producing a natural rendition of the light in very dim lighting conditions. Since EV -2 is practically the lowest light level at which you can even perceive your subject through the viewfinder, you can basically perform AE photography with the A-1 as long as you can see your subject in the viewfinder when using a film with appropriate sensitivity. This means that the A-1 will usually give you a meter reading even in the most adverse of lighting conditions when performing photomacrography and photomicrography in the stopped-down AE mode.

What this also means is that you will be using very slow shutter speeds and may be subject to failure of the reciprocity law. The reciprocity law is that relationship between apertures and shutter speeds discussed earlier in which several combinations of the two will give the same exposure value. The trouble with this law is that it may not hold true at slow shutter speeds. More exposure may be necessary. You will find information concerning reciprocity law failure and how to correct it in the data sheet that comes with your film. Correction of reciprocity failure may involve increasing the light

level so that higher shutter speeds can be used. Even when following the instructions of the film data sheet, it is advisable to slightly adjust the exposure over several shots to get at least one perfectly exposed image.

Be especially on the alert for reciprocity failure when using color reversal (slide) film which has a smaller exposure latitude than black and white or color negative film. Having a smaller exposure latitude means that it is more touchy about exposure error. Incorrect exposure by only 1/2 exposure step may make a noticeable difference in the image results. Reciprocity failure with color film will result in color shifts as well as underexposure and may require corrective filtration as recommended by the film manufacturer.

Microprism Ring

Split-Image Rangefinder



250 11

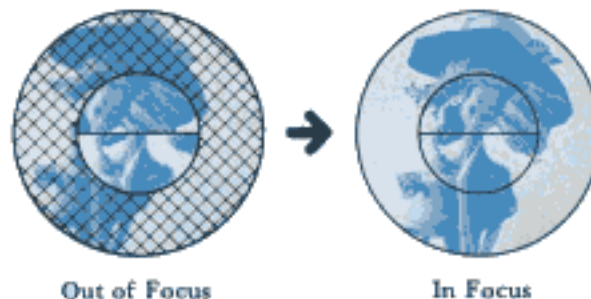
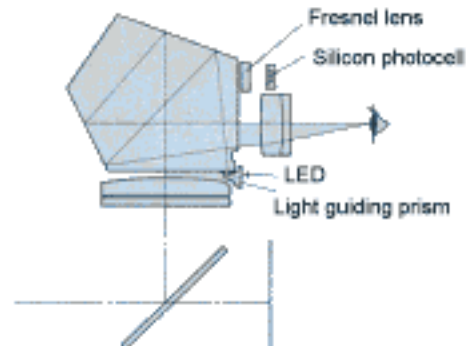

Viewfinder

A less conspicuous, unusual feature of the A-1 is the fact that, unless you are taking a meter reading, the only thing you can see in the bright viewfinder is the viewing area. All other information is eliminated, leaving you undistracted freedom to focus and compose your picture.

The A-1 uses the Central Emphasis Metering method of exposure measurement which reads the entire viewing area with emphasis on the central portion where the subject is most likely to be placed. This metering system ensures correct exposure even when skylight is present in your picture.

This camera is equipped with a split-image/micropism rangefinder focusing screen.

Viewing and Focusing

To focus, rotate the focusing ring of the lens as you view the subject through the viewfinder. Do not swing your upper body backward and forward as you focus.

The focusing screen is composed of three different focusing aids: a micropism ring and a split-image rangefinder in the central area, and a surrounding matte screen. The split-image rangefinder tells you that the image is "in focus" when the image divided horizontally in half merges to become one complete image. The micropism rangefinder presents a clear, steady image when in focus but a broken, shimmering image when not accurately in focus. When the entire image in the viewfinder is sharp, you know that the focus is correctly set. You can focus with any of these three focusing aids as you like depending on the subject and your preference.



OPTIONAL VIEWING AIDS

Dioptric Adjustment Lenses S

The dioptric adjustment lens S is an accessory which slides into the grooves of the viewfinder eyepiece from above to correct individual eyesight. With them, eyeglass wearers can photograph without glasses.

The A-1's eyepiece has a standard dioptric adjustment of -1 for normal eyesight. The following 10 kinds of dioptric adjustment lenses are optional accessories: +3, +2, +1.5, +1, +0.5, 0, -0.5, -2, -3 and -4 (diopters). The specified diopters of these lenses are recorded as the real power when attached to the camera, reflecting the -1 power of the camera's viewfinder.

You could select the appropriate dioptric lens by choosing the one closest to the number of diopters in your glasses prescription. But, we propose that you actually look

through the viewfinder after placing the dioptric lens over the eyepiece to be sure you have the best one.

Angle Finders A2 and B

There are some types of photographic subjects for which viewing them through the eye-level viewfinder of the camera is uncomfortable. This is particularly true in the fields of copying, close-ups, photomacrography and photomicrography. Then it might be more convenient to mount one of these angle finders over the camera's eyepiece. Both angle finders rotate 90° for comfortable viewing from above or from the side.

Angle Finder A2 gives a correct image top-to-bottom but reversed left-to-right while the more sophisticated Angle Finder B gives a completely normal image. Both show the entire field of view as well as viewfinder information.

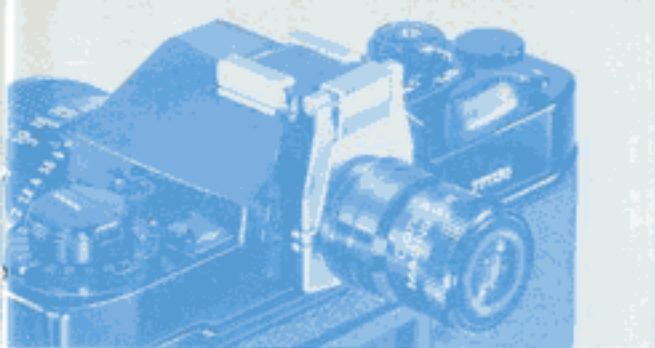

Magnifier S

The Magnifier S inserts into the grooves of the viewfinder eyepiece with its adapter to give a 2.5X magnification of the center of the viewing area for precision focusing in close-up work and wide-angle photography. Its power is adjustable to your eyesight within a range of +4 to -4 diopters. Its adapter is hinged so that the magnifier can be swung upward from the eyepiece after focusing, leaving the entire screen image visible.

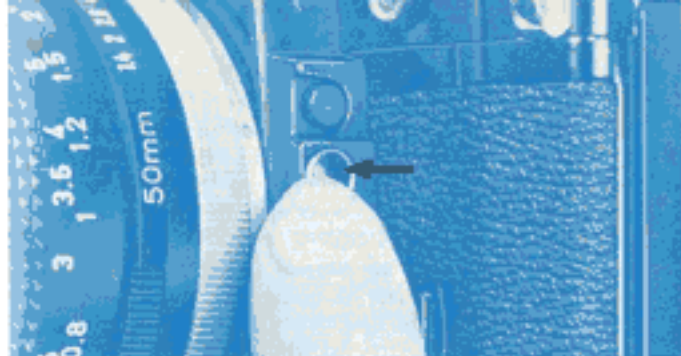

degree of LED illumination changes in four stages depending on the brightness of the subject seen in the viewfinder. When the subject is brighter, the LED brightness is slightly higher, and it is slightly lower with a darker subject. As a result, the LED maintains an almost consistent degree of brightness to the human eye.

The viewfinder information signal is transmitted to the display every half second. Accordingly, in rapidly varying light conditions, the changes in aperture or shutter speed will be indicated slightly behind time. This is a concession to the adjustment limitations of the human eye which in no way affects exposure timing.

Cancelling the Viewfinder Display

With the A-1, you have the option of turning off the viewfinder display altogether. This can be done simply by turning the viewfinder display lever to the white dot. Metering is taking place and the shutter can be released for a correctly exposed image even when the display is switched off, but it saves battery power and gives you absolute freedom to focus and compose the image undisturbed.

Numerals and Characters Composing Digital Readout in Viewfinder

Up to the first four digits from the left in the digital readout show shutter speed data ranging from 1/1000 sec. to 30 sec. All speeds from 1/2 sec. and faster will be displayed as a whole number as they are on the AT dial so that an indicated shutter speed of 500 in the digital readout stands for a shutter speed of 1/500 sec. All speeds from 1 sec. and slower will be displayed as a whole number followed by a second mark (") so that an indicated shutter speed of 8" in the digital readout stands for a real shutter speed of 8 sec. When you are in

4 sec. → 4 " 1/4 sec. → 4

aperture priority AE and the camera is calculating the shutter speed, it is possible for intermediate shutter speeds that are not on the AT dial to show up in the viewfinder. In this case, you may see such shutter speeds as 750 (1/750 sec.) or 0" 7 (0.7 sec.) displayed in the viewfinder. It is impossible to set the AT dial to an intermediate shutter speed.

1/750 sec. → 7 5 0 0.7 sec. → 0 " 7

The next two digits following the first four from the left for shutter speed data are reserved for aperture data. The possible apertures to be displayed in the digital readout range from f/1.2 to f/32 even though the minimum aperture it is possible to set on the AT dial is only f/22. The aperture data in the digital readout is displayed in 1/2 f/stop increments, giving numerical values standing for the dots on the aperture scale of the AT dial. An indicated aperture of 9.5, for instance, in the viewfinder stands for the dot between f/8 and f/11 on the AT dial aperture scale. These half f/stops are approximations which are not always exactly halfway between the full f/stops.

f/9.5 → 9 . 5

Although both shutter speed and aperture are indicated in the viewfinder in each 1/2 step increment, they are actually controlled by the camera steplessly for greatest possible precision.

There are other possible displays, including M, buLb, F, bu F, and a flashing EEEE EE. "M" is the last digit on the right in the digital readout. It appears when the camera is not set for AE control. "F" or "bu F" supplements or replaces the shutter speed data in the digital readout when the camera

is set for flash photography while "buLb" replaces the shutter speed data when the AT dial shutter speed scale is set to "B". "M" is also displayed at the "B" setting. The flashing "EEEE EE" appears to warn of error in the stopping-down process and will be explained in more detail later in this instruction booklet.

When switching from one priority to another under the same exposure conditions, it is possible that the new camera-selected variable will differ a half step from the corresponding previously manually-selected value. For instance, a combination of 1/250 sec. and $f/5.6$ in the shutter-speed priority AE mode may become 1/180 sec. at $f/5.6$ in the aperture priority AE mode under the same conditions. This is due to the fact that the camera-selected value is rounded off to half steps in the display. However, since the camera actually controls its variable steplessly, this seeming discrepancy will have no effect upon exposure.

Incorrect Exposure Warnings

The types of incorrect exposure warnings depend on what AE mode you are using.

1. In shutter-speed priority AE mode

When exposure is incorrect, the LED digital readout for aperture flashes on and off.

Underexposure

Usually the digital readout for aperture

flashes showing the lens maximum aperture to indicate underexposure. At very low shutter speeds, it is possible for a different aperture to flash on and off. For correct exposure, turn the AT dial to a lower shutter speed.

Overexposure

Aperture data from 19 to 32 will flash on and off to indicate overexposure. If the minimum aperture of your lens is equal to or smaller than the flashing aperture, exposure will be correct. If the minimum aperture of your lens is larger than the flashing aperture, increase the shutter speed for correct exposure. In other words, whenever any aperture smaller than $f/16$ appears in the readout, it will always be flashing on and off. Whether this indicates overexposure or not depends on the lens minimum aperture as described above.

There is one exception to the above which occurs when the minimum aperture of the lens is $f/32$. Since the smallest f /stop that can appear in the readout is $f/32$, when the digital readout shows 32, exposure may or may not be correct. Increase the shutter speed one step. If the readout now shows a flashing 22, exposure will be correct even at the original slower shutter speed. If 32 is still flashing once you have increased the shutter speed, increase the shutter speed even further.

There is a rare case where $f/16$ may flash on

and off in the viewfinder. If you are using a lens with an $f/16$ minimum aperture, the image may be overexposed, so increase the shutter speed. If your lens has a smaller minimum aperture, exposure will be correct.

Outside the Meter Coupling Range

When the light level is so low that it would be outside the meter coupling range regardless of the shutter speed you set, the set shutter speed will flash on and off along with the aperture in the viewfinder. When the light level is too high, a small aperture will flash on and off even when the AT dial is set to the highest shutter speed. In these cases, shooting in the shutter-speed priority AE mode is only possible if you can change the light level accordingly or switch to a more appropriate film.

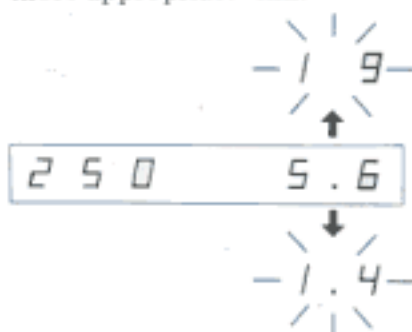

2. In aperture priority AE mode

When exposure is incorrect, the LED digital readout for shutter speed flashes on and off.

When the highest shutter speed of 1000 flashes in the viewfinder to indicate overexposure, turn the AT dial to a smaller aperture. When a shutter speed of the slow range flashes in the viewfinder to indicate underexposure, turn the AT dial to a larger aperture. The shutter speed value that flashes to indicate underexposure depends on the speed (maximum aperture) of the lens and ASA film speed.

As in the shutter-speed priority AE mode, when the light level is too low, both shutter speed and aperture data will flash on and off to indicate that no matter what aperture you set, the meter will not couple in an AE mode. When the light level is too high, the shutter speed will flash on and off even when the AT dial is set to the minimum aperture possible. Again, AE photography is still possible if you change the light level or switch to a more appropriate film.



3. In programmed AE mode

Both the shutter speed LED and the aperture LED flash on and off simultaneously to warn you of overexposure as well as underexposure. In taking exposure readings, the shutter speed and aperture combination changes as they are programmed in the camera. However, if there should be too little light to be exposed correctly even at the maximum aperture, the maximum aperture of the lens in use will remain fixed, and the camera will work in aperture priority AE, controlling the shutter speed to produce correct exposure. If the camera exceeds the limit of the meter coupling range, the shutter speed and aperture LED values that flash depend on the lens used and the ASA film speed. When the data flashes on and off in programmed AE, photography is no longer possible in that mode unless you change the light level or switch to a more appropriate film.

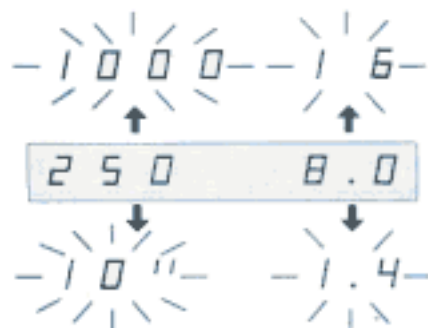

Double-Check Before Shooting

1. Is the aperture ring of the lens set to the "A" mark?
2. Have you checked the battery power level?
3. Have you properly set the AE mode selector?

The Tv setting (shutter-speed priority AE) is preferable for action photography. The Av (aperture priority AE) is preferable for still photography.

4. Did you set the film speed properly?

This is essential to the proper operation of the camera. See that the memo holder tells the type of film loaded in the camera.

5. Is the film properly loaded?

You can use the rewind knob as an indicator that the film is properly loaded. Every time you advance the film, the rewind knob should rotate.

6. Is the main switch set to the "A" mark?

At the "L" setting, the shutter button is locked.



Shutter Release

Once you have focused, composed your picture and confirmed correct exposure, gently press the shutter button all the way down to set the shutter in motion. When the shutter is released, the exposure will be stored, so there is no problem in removing your finger from the shutter button even in the slow speed range.

If you press the shutter button in one very quick stroke, the viewfinder display will become invisible and the camera's function may be delayed for an instant, but exposure metering will not be affected and your picture will be accurately exposed. If you press the shutter button with an extremely quick punch, it is possible that the shutter will not be released at all. For proper function and the least camera shake, it is best to press the shutter button gently.

To cancel shutter release, press the battery

check button or return the main switch to "L". Shutter release **WILL NOT** be cancelled in the slow shutter speed range simply by turning the AT dial to a higher shutter speed.

Pressing the shutter button will not make an exposure if the film is only partially advanced or if battery power is too low.

Rewinding the Film

When you have reached the end of the film, the film advance lever will stop suddenly before the end of its stroke. **DO NOT** force the film advance lever beyond this point or the film may become detached from the cartridge or tear, making rewinding impossible and necessitating handling the film in total darkness or a changing bag. Also **DO NOT** open the camera's back cover before rewinding or your film will be totally exposed.



To rewind the film, press in the film rewind button on the bottom of the camera. Once you have pressed it, you can remove your finger. Unfold the film rewind crank and turn it in the direction of the small arrow until the frame counter reaches the "S" mark. At this point only the film leader will not be rewound into the cartridge. *Stop rewinding here if the film is only partially exposed and you want to reload it at some other time. Also, some developing labs prefer the leader to remain protruding, and the leader may also prevent any stray light from entering the cartridge.* Otherwise you may continue to rewind past "S" until you feel no further pressure on the rewind crank. Now pull the rewind knob up sharply to open the back cover and remove the cartridge. It is preferable to place the exposed cartridge back in the canister and to have it developed as soon as possible.

Frame Counter

The frame counter of the A-1 is an additive type. It advances to the next number, indicating the number of frames already exposed, each time the film is wound. It will not advance higher than 38. The numbers 0, 20 and 36 are marked in orange, the latter two as a warning of the end or near-end of films having those numbers of frames. This frame counter is also coupled with the rewinding operation so that it counts back the frame numbers as the film is rewound. It automatically returns to "S" upon opening the camera's back cover.

The frame counter will conveniently stop during multiple exposures so that several exposures on the same frame will not be counted as separately exposed frames.

Specialized Procedures



Stopped-down AE Photography

There are basically two cases which require stopped-down AE photography (unless you wish to operate in manual override). It is necessary when you use any lens which is not FD, such as FL or R lenses or the Reflex Lens 500mm f/8 S.S.C. With the exceptions of the FD-U extension tubes or Extender FD 2x-A, it is also necessary whenever any accessory is inserted between the camera and any lens for increasing the lens' focal length or for increasing lens extension for higher magnifications in close-ups or photomacrography. It is, of course, also necessary in photomicrography. It is possible, but not necessary, to use the stopped-down AE mode when an FD lens is mounted directly onto the camera with no accessory in-between. In the stopped-down AE mode, exposure metering will be done not at full aperture as usual but, rather, at the same aperture that the picture will actually be

taken.

To set the camera in the stopped-down AE mode when using a non-FD lens, simply fold and push in the A-1's stop-down lever.

When using an FD lens, first advance the film and then disengage the lens aperture ring from the "A" mark before you push in the stop-down lever. If the film is not advanced before turning the aperture ring from the "A" mark, the lens will stop down only as far as the aperture set for the previous exposure. It is impossible to push in the stop-down lever when an FD lens is set at "A".

When in the stopped-down AE mode, it does not matter whether the AE mode selector is set to Tv or Av. The camera will behave as if it was in the aperture priority AE mode. You must select the aperture by turning the lens aperture ring while the camera will automatically select a shutter speed. When you preview the exposure, only the shutter speed

data will be displayed in the viewfinder. Unless the shutter speed data is flashing on and off, simply press the shutter button for an accurately exposed image. Exposure warnings are exactly like those in aperture priority AE. Set the aperture ring to a larger aperture if a shutter speed of the slow range flashes on and off in the viewfinder. The shutter speed value that flashes to indicate underexposure depends on the ASA film speed. Set it to a smaller aperture if the highest shutter speed of "1000" flashes on and off. When the shutter speed flashes on and off even when the aperture ring is turned to the extreme limits, you are outside the meter coupling range. Change the light level or switch to a more appropriate film.



Since you can determine correct exposure simply by watching the shutter speed data in the viewfinder, you need not keep an eye on the lens aperture ring as you turn it. However, for good depth of field when using accessories for close-up photography, it is best to close the lens to a relatively small aperture. More details are given in the instruction booklets for the various accessories involved.

You will find that your A-1 is unusually effective in photomacrography and photomicrography. Even though the amount of

light reaching the film plane is greatly reduced due to attached accessories, the A-1 is capable of metering as low a light level as EV-2 (with ASA 100 film) in the stopped-down AE mode. Furthermore, since the A-1 employs a through-the-lens meter, no exposure correction is necessary when accessories are inserted between camera and lens. When you are finished operating in the stopped-down AE mode, unfold and press down on the stop-down lever. It will pop out and the camera will be reset for full aperture metering. With an FD lens, you can now return the lens aperture ring to the "A" mark if you wish to use the A-1 in a full aperture metering AE mode.

If you return the aperture ring to "A" but leave the stop-down lever pushed in, the camera will remain in the stopped-down AE mode and all subsequent exposures will be made at the lens minimum aperture. Though exposure will be correct, this situation severely strains camera mechanisms and is not recommended.

When performing stopped-down metering, you also have the advantage of being able to confirm depth of field directly in the viewfinder. See Checking the Depth of Field.

It is not possible to shoot sequentially with the Power Winder A or Motor Drive MA when in the stopped-down AE mode using an FD lens. In this situation, only single-frame power winding is possible.



Warnings of Incorrect Operation in Stopped-down Photography

Two problems can arise if you use the camera incorrectly in the stopped-down mode. The first problem occurs if the stop-down lever of the camera is locked in before you mount the lens. If you expose a frame in this situation, it will be incorrectly exposed due to incorrect coupling of the aperture ring. To prevent this, before you mount a lens, make sure there is no red dot beside the stop-down coupling lever inside the camera body. The red dot is very conspicuous and appears only when the stop-down lever is pushed in.

The second problem arises if you push in the camera's stop-down lever and, before taking a shot, release the stop-down lever and return the lens aperture ring to the "A" mark. If you then try to press the shutter

button, you will notice that neither it nor the film advance lever will operate. What's more, this is when the "EEEE EE" mark will flash in the viewfinder whether the viewfinder display switch is turned off or not.

This appears to be a distressing situation, but it is very easily corrected. Push the film advance lever into its retracted position close to the camera body. The multiple exposure lever is underneath. Push it to the left. Now turn the film advance lever. With this operation, the camera will work in the normal way.





Manual Override

You may have occasion to wish to cancel the A-1's AE capabilities to control exposure, both aperture and shutter speed, by yourself. This will be the case if you are using a separate exposure meter, if you wish to correct exposure in unusual lighting conditions or in flash photography, or if you want to control exposure for creative effects.

With the A-1, this is a simple process. Using an FD lens, first disengage the aperture ring from the "A" mark. Set the AE mode selector to Tv. The Av setting is useless. Set the aperture by turning the lens aperture ring, and set the shutter speed by turning the AT dial. When you press the exposure preview switch or the shutter button halfway to preview the exposure, the data displayed in the viewfinder will be the same as if the camera was in shutter-speed

priority AE. You will see the shutter speed you have set on the AT dial. The aperture displayed is that that the camera would select on Auto. Although the aperture you have manually set on the aperture ring is not displayed, it is at that aperture that your picture will be exposed when you press the shutter button. You will also see the red "M" inside the viewfinder to indicate that you are in the manual mode.

To operate the camera manually using an FL lens or any other lens without a full aperture signal pin, set the AE mode selector to Tv. With these lenses you must always set the aperture by turning the lens aperture ring. In the case of these lenses, the digital readout is unreliable, and it is better to cut it out altogether by switching off the viewfinder display lever. You must rely on your own experience for setting the exposure.

With an FD lens, if you set the AE selector to Av instead of Tv while the lens is away from the "A" mark, the digital readout will show the aperture you have set on the AT dial plus the corresponding camera-selected shutter speed as in aperture priority AE along with "M" for manual aperture setting. Although you are no longer in manual override, it is possible to make an exposure correction by setting the lens aperture ring to a different aperture than that on the AT dial. Exposure will be made at the aperture set on the lens aperture ring and the camera-selected shutter speed.



Self-Timer

The self-timer is usually used either so that you can include yourself in a picture or as an alternative to a cable release for the softest possible shutter release in delicate photography, such as photomacrography and photomicrography, or on other occasions when long exposures are necessary. This particular self-timer allows a time-lag of either two or ten seconds.

To use the self-timer, first make sure the film is wound and that the shutter speed is not at "B". If the film is not wound, the self-timer will act, but the shutter will not. The self-timer will not function normally at "B". Now set the main switch to 2 or 10. Focus and compose your picture. You may press the exposure preview switch to check the exposure. However, remember that, since the A-1 is designed to reflect any last-second changes in exposure when in an



AE mode, it will not set the exposure until a split second before the shutter itself is actually released. Once you have completed these preparations, flick the eyepiece shutter lever to close the eyepiece shutter so that no light comes through the eyepiece to affect the exposure. Now press the shutter button and run into place if your purpose is to include yourself in the picture. The shutter will be released automatically following the time interval you have set.

The moment you press the shutter button, the self-timer lamp starts to flash at the rate of two flashes per second. At two seconds before shutter release, it starts to flash eight times per second to warn you of impending shutter release.

If you wish to cancel the self-timer before shutter release, either switch the main switch to the "L" position or press the battery check button.

You may repeat the self-timer process as many times as you wish. After completing self-timer photography, return the main switch to either "A" or "L".

Please note that the eyepiece shutter should be closed whenever exposure is to be determined when your eye is not to the eyepiece. This is applicable to self-timer photography, remote control photography and often to tripod or copy stand photography and is especially important in night photography.



EXPOSURE COMPENSATION

You can, of course, make exposure corrections by operating the camera manually, but the A-1 is also equipped with other devices which allow you to correct the exposure while in an AE mode.

Unusual lighting conditions which necessitate exposure correction include those instances when light takes up the major part of the viewing area, such as in beach or snow scenes, and contre-jour or backlit situations in which light is shining behind the subject, such as when your subject is in front of a window or when a lamp or the sun is shining behind him/her. In such situations, the camera might be fooled into giving a reading which would underexpose your subject, so you must give it more exposure than the camera shows in AE. This also applies to high-key or intentionally overexposed shots. On the other hand, it is necessary to reduce the exposure for a low-key shot. Some correction may also be necessary if your sub-

ject is not located in the central part of the viewing screen.

Exposure Compensation Dial

One device for correcting exposure in the AE mode is the exposure compensation dial. To make the correction, simply hold in the exposure compensation lock button while turning the outer knurled edge of the ASA setting dial until the compensation dial index is aligned with the desired correction. The exposure compensation scale covers a full ± 2 f/stop range in indications of 1/4 (underexposure by 2 f/stops), 1/2 (underexposure by one f/stop), 1 (normal AE exposure), 2 (overexposure by one f/stop) and 4 (overexposure by two f/stops). The scale is engraved in 1/3 f/stop increments so that intermediate settings may be used. The latter may come in handy for bracketing the exposure.

Since the digital readout is in only 1/2 f/stop increments, depending on the situation, the readout will not necessarily change to indi-

cate an exposure adjustment of only 1/3 f/stop, but your picture will be exposed in the 1/3 f/stop increment you set on the dial.

Generally, exposure should be corrected whenever the high-key (light) or low-key area occupies more than half of the total viewing area. How much more or less exposure should be given depends on the lighting condition as roughly described below. However, these are only general guidelines meant to help you while experimenting.

Some situations require special measures. For instance, when shooting a subject against the sun or some other exceptionally strong light source, requiring drastic exposure correction, or when you shoot a subject in an unvarying lighting condition such as under photolamps in a studio, it

may be better to use the exposure memory switch as explained on the next page or manual override.

The exposure compensation dial can also be used to correct exposure in multiple exposures as explained later.

Usable Range of Exposure Compensation Dial According to ASA Rating

ASA6:	1/4•1/2•1
ASA12:	1/4•1/2•1•2
ASA25-3200:	1/4•1/2•1•2•4
ASA6400:	1/2•1•2•4
ASA12800:	1•2•4

Once you have made an exposure correction on a specific frame using the exposure compensation dial, do not forget to reset the dial to its original setting. Otherwise, all following frames will be incorrectly exposed.

Scale	Exposure Correction	Application
1/4	2 f/stops underexposure	Black background
:		Spot lighting
1/2	1 f/stop underexposure	Black background occupying half of viewing area
:		
1	Normal	Overhead interior lighting
:		Subject by a window
2	1 f/stop overexposure	Blue sky or sea backgrounds occupying half of viewing area
:		Contre-jour portrait, white background, snow scene or blue sky background
4	2 f/stops overexposure	

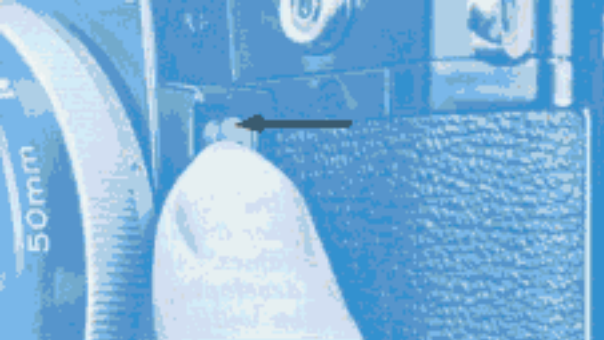

Exposure Memory Switch

The A-1 also offers an exposure memory switch for correcting the exposure in the AE mode. Essentially, this switch assures correct exposure by exposing the picture for your subject no matter what the surroundings are. When you press in the exposure memory switch, it locks the exposure value (EV) for whatever you are metering. You can then compose the picture as you wish, and it will come out correctly exposed for whatever you metered. An extra advantage in this is that, depending upon whether you are in the shutter-speed priority or aperture priority AE mode, you can change either one and the camera will automatically select the other to arrive at the same locked-in exposure value.

For instance, suppose you want to take a portrait of a subject against the sun. First move in closer to your subject until it is centered in and taking up about one-third of

the total viewing area. Push and hold in the exposure memory switch to lock the exposure value metered for your subject. Now step back and compose the picture as you like. Change the aperture or shutter speed, depending upon which priority you are in, if necessary. Continuing to hold in the exposure memory switch, press the shutter button. Your subject will be correctly exposed.

Of course, you have a problem if you cannot approach your subject to meter it directly. Then try to find an approachable subject which you think would give the same exposure value as your subject. Meter it, push in and hold the exposure memory switch. Compose your subject and shoot for correct exposure.

Please note that you must hold in the exposure memory switch until after you press the shutter button. It does not lock.



Changing the ASA Setting

There is another way to correct exposure which can be used whether you are in the manual or the AE mode. That is to change the ASA film speed setting on the camera. A film with an ASA rating twice that of another film requires only half the amount of light for correct exposure as compared with the other film. For instance, if you have an ASA 200 film loaded, you can make an exposure correction equal to closing the aperture one f/stop or raising the shutter speed one step by changing the ASA setting on the camera to ASA 400.

Other useful tricks can be performed by changing the ASA setting. You may be stuck, for instance, indoors without flash. Even with ASA 400 film loaded in your camera, you may be forced to use undesirably slow shutter speeds. You may solve this by "pushing" the ASA setting on the

camera to a higher value. Usually this is done by multiplying the normal ASA rating by some multiple of two, say by two or four. In this case, the whole roll of film must be shot at the "pushed" ASA or you will have to sacrifice one or the other of a whole series of frames. Also, do not forget to inform your developing lab of the change or the whole film will be incorrectly developed. This is only an introduction to this technique. Not all films can be "pushed" and not all developing labs will handle them. Read more about "pushing" the ASA in photographic literature and know what you're doing before you try it.

This trick should not be confused with the above which involves intentional exposure correction for only one frame after which the ASA dial should be reset to its original value.

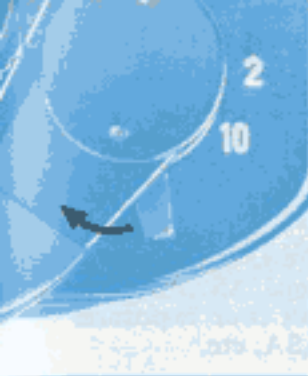

Multiple Exposures

Making two or more exposures on the same frame is an exciting technique which is very simple to perform with the A-1. After making the first exposure, do not turn the film advance lever but return it to its retracted position close to the camera body. Switch the multiple exposure lever underneath the film advance lever to the left. A red dot will appear indicating that the camera is set for a multiple exposure. Now turn the film advance lever. The film will remain stationary, holding its exact position. At the same time the shutter will be re-cocked, and the multiple exposure lever will automatically return to its original position over the red dot. When you press the shutter button, your second shot will be in exact registration over the first. If you turn the film advance lever, the camera will be set for the next frame.

You can make any number of exposures on the same frame simply by repeating the above procedure before turning the film advance lever. There is a possibility of a slight movement of the frame if you make an excessive number of exposures on the same frame, if you turn the film advance lever too forcefully or if there is film slack. The frame counter is stopped until you actually advance the film to the next frame.

Once you have set the camera for a multiple exposure, there is no way to cancel the process before actually making it. If you suddenly decide you don't want a multiple exposure but still want to preserve the one or several shots you have already made on the frame, you have the best chance of doing that if you manually set the lens aperture ring to the minimum aperture, the shutter speed to 1/1000 sec., cover the lens with the lens cap and then release the shutter.

Multiple exposures are not possible when the Motor Drive MA or Power Winder A is mounted on the A-1 and in operation. They are possible even when these accessories are mounted if you switch them off and advance the film manually.

There are some situations which seem to call for a multiple exposure but which are better handled in another way. One of these is recording multiple bursts of fireworks on the same frame. Rather than using the multiple exposure lever, mount the camera on a tripod, set the shutter speed at "B", and set the aperture ring manually to the appropriate f/stop according to the following table. Hold the shutter open with a cable release until several bursts are registered on the frame.

ASA	25	50	100	200	400
f/stop	5.6	8	11	16	22

Exposure in Multiple Exposures

Generally, the first exposure of a multiple exposure should be of a relatively dark subject so that the image in the next exposure will show up clearly. For best results in multiple exposures, it is also advisable to decrease the exposure for each shot. Depending on the situation, there are several ways to do this. One way is to change the

ASA to a higher value as described earlier. In this method, you must first decide how many exposures you want to make on the same frame. If a double exposure, make both exposures at twice the normal ASA; if a triple exposure, make all three exposures at three times the normal ASA; if a quadruple exposure, make all four exposures at four times the normal ASA, etc.

Another way to correct exposure is to use the exposure compensation dial at the settings outlined in the table below.

Number of Multiple Exposures	Exposure Compensation Scale
Double	1/2
Triple	Between 1/2 and 1/4
Quadruple	1/4

The method when using the exposure compensation dial for this purpose is the same as that of changing the ASA. That is, for a double exposure, the dial should be set to 1/2 for both exposures and so on. Actually, both methods described above are only general guidelines, and your technique will benefit greatly from experience.



Film Plane Indicator

This mark is engraved on the top of the camera beside the film rewind knob, just to the left of the pentaprism, to indicate the exact position of the film plane. It is not used in general photography, but it is helpful in close-up photography and photomacrography for obtaining the exact shooting distance from film to subject.

Distance Scale

The distances on the scale are calibrated from the film plane to indicate the focused distance from film plane to subject.

The scale is not generally used except when confirming depth of field, performing guide number calculations in flash photography, or using infrared film.

Read one-digit distances in the middle of the number marked on the scale. Two-digit distances should be read at the point between the two digits.

Infrared Index Mark

Since infrared light rays have longer wavelengths which focus on a plane slightly behind that of ordinary visible light rays, it is necessary to slightly adjust the focus of the lens when using black and white infrared film. The infrared index mark engraved on the lens barrel is used for this purpose. After focusing the same as usual, note the tiny red dot engraved on the lens barrel just to the right of the distance index, and turn the focusing ring to align the focused distance with this red dot. For instance, if the focus is at 10m on the distance scale, turn the focusing ring to align the 10m mark with the red dot. After that focusing correction, you can release the shutter.

When using infrared black and white film, visible light rays must be kept out by means of a deep red filter (R1) over the lens. When using infrared color film, there is no need to

make a focusing correction. Follow the detailed instructions of the film manufacturer.

The position of the infrared index mark has been computed for the use of infrared film with peak sensitivity at 800nm (such as Kodak IR 135) and a red filter such as Wratten 87.



Checking the Depth of Field

There are two ways to find out what the depth of field is. One is by using the depth of field scale which is a series of f /stops repeated on each side of the distance index mark on the lens barrel. The scale differs according to the lens. First focus your subject. Find the two f /stops on the depth of field scale which correspond to the aperture you or the camera have set for the exposure. Draw imaginary lines from these two f /stops to the distance scale. The effective depth of field extends between those two distances. For example, using a standard 50mm lens focused at 3m with the aperture set at $f/8$, depth of field extends from 2.4m to 4.5m. Any subject from 2.4m to 4.5m away will be in reasonably sharp focus in the image.

You can also visually check the depth of



field looking at the image through the viewfinder by pushing in the stop-down lever just as in stopped-down AE photography and setting the lens to the working aperture. This will probably be one of those occasions when you will release the stop-down lever and return the lens to "A" before taking a shot. You will have to operate the multiple exposure lever as explained earlier before the camera will properly operate. See **WARNINGS OF INCORRECT OPERATION IN STOPPED-DOWN PHOTOGRAPHY**, p. 64.



Small Aperture



Large Aperture

Positioning Pin

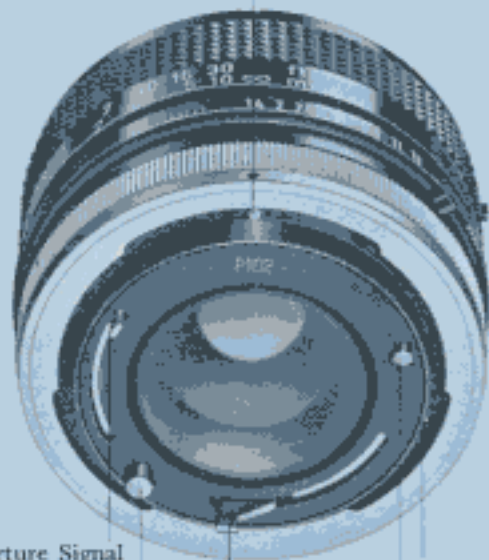

Aperture Signal
Lever

Full Aperture
Signal Pin

Automatic
Aperture Lever

EE Switch Pin

Reserved Pin

Lens Signal Coupling

There are several levers and pins at the rear of an FD lens which transmit signals between the lens and the camera body. Usually it is not necessary to know what they are, but sometimes, when you must operate the aperture manually for non-coupled accessories for instance, it is. Just for your information, we include explanations of them here.

1. Aperture Signal Lever

With an FD lens, exposure metering is performed through the lens at full aperture. This is nice for you since you have a bright viewfinder to focus and compose, but to determine correct exposure, the camera must know the effective aperture. For most cameras, such as the Canon F-1, this lever transmits the preset aperture on the lens aperture ring to the exposure meter. It is coupled to the lens aperture ring and moves in proportion to its rotation. In AE photography, however, the exposure meter receives a signal directly from the camera.

2. Automatic Aperture Lever

This lever couples to the camera body to stop the diaphragm down to the preset aperture just before the shutter releases. This is the lever that must be locked for manual diaphragm control with a non-coupled accessory.

3. Full Aperture Signal Pin

This pin transmits the maximum aperture of the lens to the exposure meter to set the meter coupling range automatically.

4. EE Switch Pin

When the "A" mark of the aperture ring is set to the aperture index, the EE switch pin comes out to insure that the lens, at this setting, can be mounted only on cameras designed for AE photography.

5. Reserved Pin

This pin is designed for use with additions to Canon's camera system that may be developed in the future.

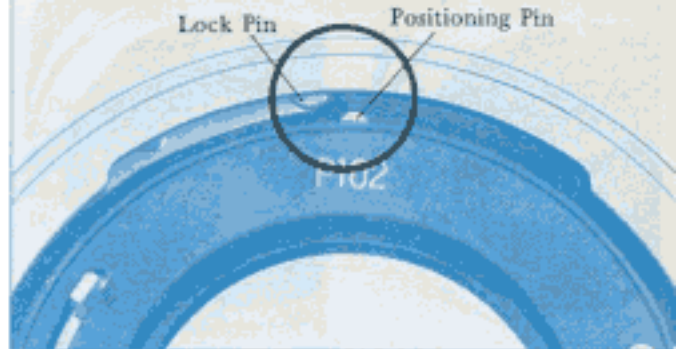

Seeing the Lens in Action

FD lenses incorporate a safety feature to prevent the Breech-Lock bayonet ring and diaphragm blades from moving when the lens is dismounted. If you want to check the diaphragm's operation, press the lock pin in the top recess of the Breech-Lock mount while turning the bayonet ring and lock the automatic aperture lever (see p.80). Then turn the aperture ring and watch the diaphragm blades.

Be sure to reset the automatic aperture lever to its normal position before using the lens once more in direct contact with the camera body.

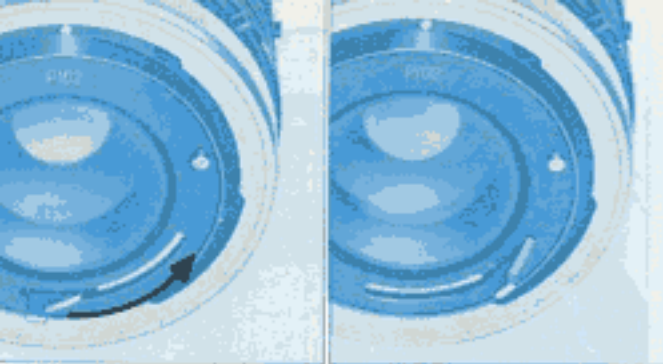

Automatic Diaphragm Control

When the A-1 is directly coupled with an FD lens, diaphragm control is totally automatic. Exposure metering is performed at full aperture whether the lens aperture ring is at the "A" mark or set to a specific aperture. At shutter release, the diaphragm automatically closes down to the aperture set by the camera or by you with the AT dial or the aperture ring. Following shutter release, the lens automatically returns to maximum aperture.

Manual Diaphragm Control

The insertion of non-automatic accessories between the camera body and lens may call for manual diaphragm control. The instructions for these accessories will tell you whether or not this is necessary.

1. Before attaching the lens, push the auto-

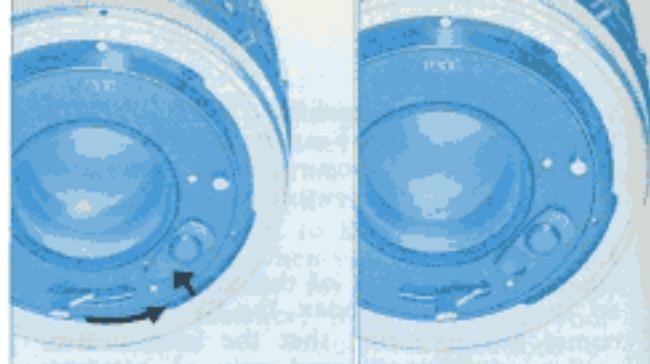

matic aperture lever to the right where it locks.

2. Mount the lens onto the accessory and secure the Breech-Lock bayonet ring. The aperture ring will now act directly on the diaphragm.

A few FD lenses have an additional lock lever which holds the automatic aperture lever in the "automatic" position. With these particular lenses, the automatic aperture lever must be pushed fully to the right while pushing the lock lever to the "L" position.

Be sure to reset the automatic aperture lever to its normal position before using the lens once more in direct contact with the camera body. In the case of a lens with a lock lever, switch it back to the position of the white dot.

Manual diaphragm control will also be necessary if you wish to mount the lens in reverse



with the aid of a macrophoto coupler. This is supplied with a macro hood allowing the Breech-Lock ring to be unlocked and turned fully to its "closed" position after the automatic aperture lever is pushed all the way to the right.

To meter when the lens is set for manual diaphragm control, use the stopped-down AE procedure.

Unusable Lenses

Out of the several series of Canon lenses, there are a few older individual lenses which cannot be used on the A-1. Do not attempt to mount the following five lenses:

FL 19mm f/3.5

FL 58mm f/1.2

R 58mm f/1.2

R 100mm f/3.5

FLP 38mm f/2.8



FLASH PHOTOGRAPHY WITH THE A-1

AE Flash Photography

There are two special automatic flash units, the Canon Speedlites 199A and 155A, which make AE flash photography possible with the A-1. Just slip the Speedlite into the accessory shoe, switch it on, focus and shoot. It does not matter whether the AE mode selector is set to Av or Tv. Except for "B", whatever the shutter speed set, as soon as the pilot lamp of the Speedlite comes on, the A-1 switches to the X synchronization speed of 1/60 sec. -- automatically. The camera's microcomputer controls the light output for perfect automatic exposure within auto working ranges. And just as automatically will the camera switch back to the shutter speed actually set on the dial as soon as the pilot lamp goes out. The viewfinder offers you full information needed for flash photography. Moreover, when the main switch of the Speedlite is turned off, the flash circuitry is completely cut off and the A-1 switches over to function as an AE control camera with the Speedlite mounted on it.

Of course, with the flash still on Auto you can set the aperture manually should you wish to use an FL lens. Even then, however, the camera will automatically switch to 1/60 sec. as soon as the Speedlite

is ready for firing.

Both the Speedlite 199A and 155A employ a unique light sensing system which reduces excessive reflection from the central area to give better overall exposure.

With the Speedlite 199A, shutter speeds slower than 1/60 sec. can be optionally selected for the effect of a lighter background. It is a powerful flash unit with a guide number of 30m (ASA 100). To control depth of field, you can choose between three working apertures (f/2.8, f/5.6, and f/11 for ASA 100 film) that are automatically preset by the camera as soon as the pilot lamp comes on. The 199A also allows bounce flash and flash coverage of a 24mm lens field with the wide angle adapter. Its thyristor circuit offers you continuous flash shooting at close distances.

General Flash Photography

When you use the A-1 with flash units other than the Speedlites 199A and 155A, set the AE mode selector to Tv and the shutter speed to 1/60 sec. or slower. With this setting on the camera, other types of electronic flash units can be synchronized with your A-1 either through the hot shoe or via the PC socket on the front of the camera body. These allow two separate flash units to be fired simultaneously.

Aperture should be manually set on the



aperture ring to the working apertures specified for an automatic electronic flash or be determined through a guide number calculation using the following formula.

$$\text{Aperture} = \frac{\text{Guide Number}}{\text{Shooting Distance}}$$

When doing the math, make sure that the guide number and shooting distance are both in the same unit, whether meters or feet.

The fastest shutter speed for use with electronic flash is 1/60 sec., for use with M or FP bulbs, 1/30 sec.

Digital Readout in Flash Photography

When you preview exposure in flash photography, the digital readout will differ depending on the type of flash photography.

1. AE Flash with Canon Speedlites 155A or 199A and an FD Lens

The flash is on Auto while the lens is set to the "A" mark. The digital readout will display a shutter speed of 1/60 sec., the flash signal "F" and the auto working aperture set on the flash as follows: 60 F 2.8. The A-1 automatically switches to 1/60 sec. when the flash is charged regardless of the shutter speed set as long as it is not set to "B". The "F" flash signal appears in the viewfinder only when the flash pilot lamp lights up to indicate that the flash is charged. Thus, you will know the flash is ready simply by looking in the viewfinder. The aperture value displayed is the auto working aperture you have set on the flash depending on the ASA film speed. (The aperture displayed in the readout may be 1/2 f/stop larger or smaller than the auto working aperture set on the flash though the auto working aperture is the effective aperture). The auto working aperture value is automatically set on the camera.

Exposure warnings are very similar to those in shutter-speed priority AE. If you have set an auto working aperture larger than the maximum aperture of the lens, the maximum aperture of the lens will flash on and off to indicate underexposure. If you have set an auto working aperture smaller than f/16, the set auto working aperture will flash on and off. If the minimum aperture of the lens is equal to or smaller than the flashing aperture, exposure will be correct. If larger, the image will be overexposed.

If, with Speedlite 199A, you want to use a shutter speed of 1/30 sec. or slower, set the AE mode selector to Tv and the AT dial to the desired shutter speed and set the shutter speed selector switch on the 199A to the MANU position. In this case, the shutter speed on the AT dial will be displayed in the readout.

A rectangular digital readout display with a light beige background and a thin black border. It shows the text "60 F 2.8" in a black, sans-serif font. The "60" is on the left, "F" is in the middle, and "2.8" is on the right, with small gaps between them.

2. Automatic Flash Control with Canon Speedlites 155A or 199A

The flash is on Auto but the aperture is manually set by turning the lens aperture ring. This type of automatic flash control is necessary with an FL lens and other non-FD lenses and possible with an FD lens when it is not set to "A".

The digital readout will be the same as in AE flash control but will also include the "M" signal for manual aperture control. Though the set flash auto working aperture value is displayed in the readout, it is not automatically set as in AE flash control. The same aperture value as set on the flash must be manually set on the lens aperture ring. As in AE flash control, the shutter speed is automatically set at 1/60 sec. as long as the AT dial is not at "B".

When using an FD lens, exposure warnings are the same as those for AE flash control. Since FL lenses lack a full aperture signal pin, you cannot always rely on the digital readout of apertures and exposure warnings. It is, therefore, advisable to switch off the viewfinder display lever.



B 0 F 2.8 M

3. Manual Flash Control with Canon Speedlites 155A or 199A

The flash is on Manual and the aperture is determined by a guide number calculation and then set manually on the lens' aperture ring. The digital readout will include shutter speed, "F" flash signal and the "M" signal for manual aperture control. No aperture data will be displayed. *When the flash is set to Manual, the viewfinder will display "M" even if an FD lens is at the "A" mark.*



B 0 F M

4. Long Exposures with Canon Speedlites 155A and 199A

When the shutter speed is at "B", the shutter speed data in the digital readout will be replaced by "bu" for "bulb". The remaining information as well as exposure warnings remain the same as in each of the above three cases.

For example:

1) AE Flash



bu F 2.8

2) Automatic Flash

b u F 2.8 M

3) Manual Flash

b u F M

The "B" setting is useful in flash photography for obtaining intentionally blurred images or a zooming effect. At this setting, the flash of the Speedlite synchronizes with the opening of the first shutter curtain.

5. Ordinary Flash Photography with Flashes other than the Canon Speedlites

When flashes other than the two special Canon Speedlites are used with the A-1, the digital readout will include the same information as in manual override. See p. 65. However, since the aperture displayed has no meaning in this case, it might cause less confusion to switch off the viewfinder display lever.



MOTORIZED FILM WINDING

There remains one last mechanical operation in the A-1 that could possibly distract your attention from your subject: you have to wind the film. Canon has solved that problem for you too. Both the miniaturized Canon Power Winder A, originally designed for the AE-1, and the Canon Motor Drive MA, specially developed as a natural extension of the A-1's AE possibilities, automatically wind the film and recock the shutter without your ever having to touch the film advance lever, all even when you are using the A-1 in an AE mode (except for stopped-down AE).

The Motor Drive MA is a compact, high-performance device employing Monolithic IC and an electromagnetic clutch. It offers a selection of three speed settings: H (max. 5 fps), L (max. 3.5 fps) and S (single frame). With the Battery Pack MA, the unusually high speed (H) is instantly accessible for those fast-breaking situations. For maximum ease of operation, there is also a selection of three shutter buttons depending on how the camera is hand-held.

Both accessories stop automatically at the end of the film at which time an LED glows steadily to tell you that the roll is completed. They mount onto the A-1 with ease, and, even when mounted, can simply be switched off to wind the film manually.

DATA BACK A

Within seconds, the A-1's back cover can be exchanged for the Data Back A, which, again, becomes an integral part of the camera's electronic system. As you press the shutter release, the day, month and year will be recorded clearly but unobtrusively in the lower right hand corner of every picture, i.e., unless you decide to leave it blank. Since letters and Roman numerals are also available, the Data Back can serve as a convenient coding system as well.



Various Accessories for Close-ups and Photomacrography

Canon offers a whole gamut of accessories which give you unlimited possibilities in close-ups, photomacrography and photomicrography. At the center of the system stands the elegant, versatile Auto Bellows featuring a three-way focusing mechanism, immediate lens reversal and automatic diaphragm coupling with the Canon Double Cable Release. For higher magnifications with excellent image quality there are the specially aberration-corrected Macro and Macrophoto lenses. A Macro Stage and three slide duplicators provide the maximum of ease in shooting difficult subjects.

Of course, close-up lenses and reversing rings are also offered along with three sets of extension tubes. The remarkable set of extension tubes FD-U permit full-aperture metering, automatic diaphragm coupling and AE photography with the A-1. There is also a simpler bellows unit, the Bellows M. Even with these non-automatic accessories, the Macro Auto Ring and Double Cable Release preserve automatic diaphragm coupling. Canon's extra-large, ultra-stable Copy Stand 5, the smaller Copy Stand 4, a small, collapsible copy stand, camera supports, a Focusing Rail, cable releases and microscope adaptors round out Canon's up-to-date, integrated, comprehensive close-up system.

ACCESSORIES

1. Angle Finder A2 and B
2. Eyecup 4S
3. Magnifier S
4. Camera Holder F3
5. Macrophoto Coupler FL 55 and FL 58
6. Lens Hood BS-55
7. Microphoto Hood
8. Photomicro Unit F
9. Slide Duplicator
10. Handy Stand F
11. Gadget Bag 4-type
12. Gadget Bag G-1
13. Canon Release 30
14. Canon Release 50
15. 55 mm filters
58 mm filters
16. 58 mm Close-up Lenses
(240, 450)
17. 55 mm Close-up Lenses
(240, 450)
18. Macrophoto Lens 20 mm $f/3.5$
19. Macrophoto Lens 35 mm $f/2.8$
20. Duplicator 8
21. Duplicator 16
22. Duplicator 35
23. Focusing Rail
24. Macro Stage
25. Roll Film Stage
26. Double Cable Release





- 27. Copy Stand 5
- 28. Copy Stand 4
- 29. Auto Bellows
- 30. Bellows M
- 31. Bellows FL
- 32. Extension Tube M Set
- 33. Extension Tube FD 25-U and FD 50-U
- 34. Extender FD 2x-A
- 35. Dioptric Adjustment Lens S (10 kinds)
- 36. Speedlite 155A
- 37. Speedlite 199A
- 38. Motor Drive MA
- 39. Battery Pack MA
- 40. Ni-Cd Pack MA
- 41. Power Winder A
- 42. Data Back A
- 43. Action Case A
- 44. Holder for Gelatin Filter with Filter Holder Adapter and Hoods
- 45. Wireless Controller LC-1

- ① Speedlite 199A
- ② Speedlite 155A
- ③ Data Back A
- ④ Ni-Cd Charger MA
- ⑤ Ni-Cd Pack MA
- ⑥ Motor Drive MA
- ⑦ Battery Pack MA
- ⑧ Battery Magazine MA
- ⑨ Power Winder A

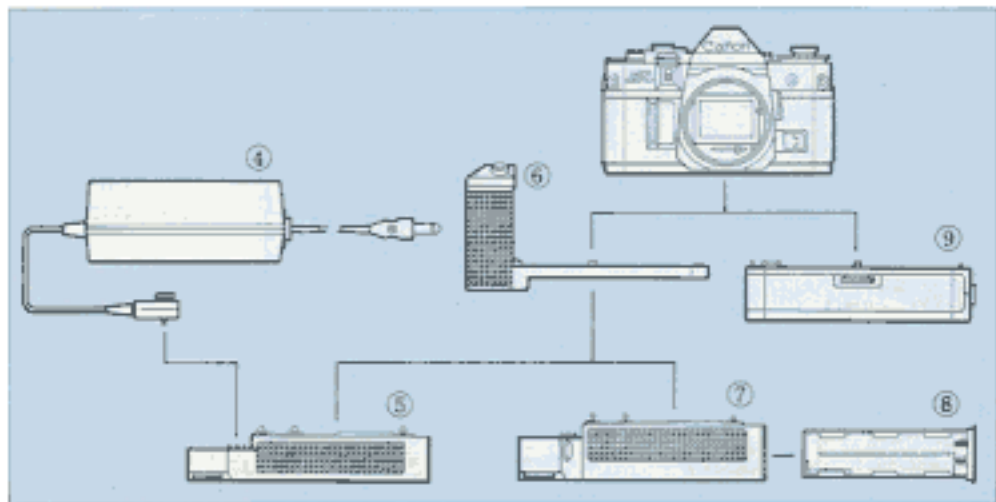
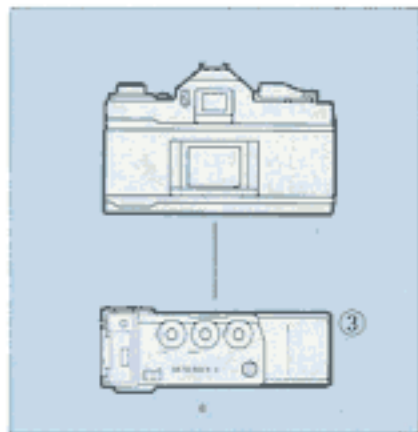
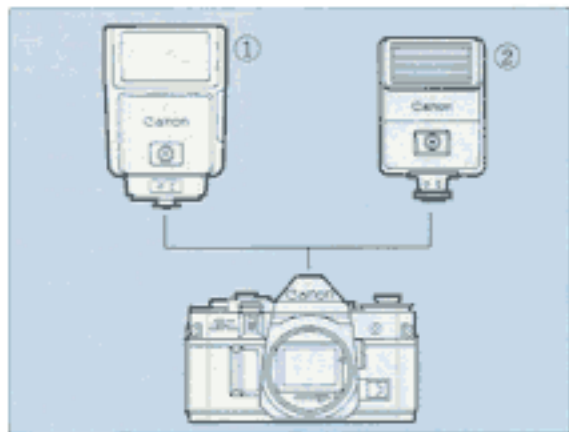

Proper Care of the Camera

Your A-1 is a rugged, high-quality camera. It will work properly if operated and cared for properly. Never force anything. If you have a problem that is not answered in the instructions below, follow the advice of your nearest Canon serviceman. We recommend taking the A-1 to an authorized Canon service facility at least once every three years for a complete checkup.

Storage

The best thing you can do for your A-1 is to use it regularly, but in the event that it won't be used for quite a while, first remove it from any camera bag or soft case. Then remove the battery to prevent possible corrosion to the terminals. Recap the lens, and if the body is stored separately from the lens, put the body cap and the rear lens cap on. Wrap it in a clean, soft cloth along with silica gel or some other desiccant to keep it dry, and store it in a cool, dry, dust-free place. Avoid storing it in the rear window, glove compartment or other "hot spots" of an automobile, in a place such as a laboratory where chemicals could cause corrosion and rust, or in a dusty, damp, or hot place. Keep it out of direct sunlight. Before using the A-1 after it has been stored for a long

time, carefully check the operation of each part.

Cleaning the Camera and Lens

Before doing anything else, clean the camera with a blower brush. It is best to have two blower brushes, one for the camera body and the lens barrel, the other for the lens surfaces, eyepiece and mirror. If the blower brush is sufficient to get the camera clean, stop there. By all means, avoid touching the lens. Should you accidentally get fingerprints or smudges on the lens or eyepiece, use lens tissue (not eyeglass tissue!) or a clean, soft, untreated cloth, after breathing on the lens surface, if necessary. Never use a handkerchief, facial tissue or any other cloth which might permanently scratch the lens, and never use a cloth treated with a chemical which might totally ruin the lens coating.

Put only one or two drops of lens cleaning fluid on the tissue, not the lens, and, starting at the center of the lens, lightly wipe it while working towards the outer edges in a circular motion. Use a silicon cloth, if necessary, to wipe smudges off the camera body and lens barrel only. The mirror is another part you should never touch. A dirty mirror does not affect the image though it may impair viewing. If it is dusty, clean it very gently with the lens blower brush. If more cleaning

is necessary, do not attempt to do it yourself but take it to an authorized Canon service facility. The film compartment also requires occasional cleaning with a blower brush to remove accumulated film dust particles which might scratch the film. When doing this, take special care NEVER to exert pressure on the shutter, the rail surfaces or the pressure plate.

Salt and sand are your camera's worst enemies. After using it on a beach, clean it thoroughly. If you accidentally drop it in the water, it may be irreparable but take it immediately to an authorized Canon service facility.

Using the Camera in Extremely Cold Conditions

In extremely cold conditions, always protect the camera from outside air and try to finish shooting as quickly as possible.

In temperatures below 0°C (32°F), the battery may be affected, so you may want to carry a spare. Keep the camera and spare battery close to your body or in a pocket to keep them warm until you are ready to take a picture. Although the battery may not function well in cold conditions, don't throw it away. It may work perfectly again when you use the camera in warmer temperatures.

Avoid extreme temperature changes. Condensation forming on a camera and lens taken from subzero outside temperatures into a warm room may cause corrosion. Let the camera gradually adjust to the temperature change by placing it in a completely sealed plastic bag for a while.

SPECIFICATIONS

Type: 35mm SLR (Single-Lens Reflex) camera with selective, electronically controlled AE (Automatic Exposure) and focal plane shutter.

Format: 24 x 36mm.

Photographic Modes: Six modes; including five AE modes: shutter-speed priority AE, aperture priority AE, programmed AE, full AE flash photography with specified Canon electronic flashes, and stopped-down AE; and manual override.

Interchangeable Lenses: Canon FD series lenses (usable with four full-aperture metering AE modes and stopped-down AE); Canon FL series lenses (usable with stopped-down AE).

Standard Lenses: Canon FD 55mm and 50mm lenses.

Lens Mount: Canon Breech-Lock mount. Canon FD, FL and R lenses can be mounted.

Viewfinder: Fixed eye-level pentaprism.

Field of View: 93.4% vertical and 95.3% horizontal coverage of the actual picture area.

Magnification: 0.83X at infinity with a standard 50mm lens.

Focusing Screen: Standard split-image/

microprism rangefinder.

Viewfinder Information: Displayed in form of LED digital readout below viewing area. Includes shutter speed (1/1000 sec.—30 sec.), aperture (f/1.2—f/32), flashing warning of incorrect exposures and settings, bulb indication, charge completion indicator for specified Canon flash units, manual aperture control signal, error indication for incorrect stopping-down operation. Shutter speed and aperture data displayed in 1/2 step increments. Viewfinder information can be cancelled by turning off viewfinder display switch.

Dioptric Adjustment: Built-in eyepiece is adjusted to standard -1 diopter.

Eyepiece Attachments: Angle Finders A2 and B, Magnifier S, 10 different Dioptric Adjustment Lenses S for eyesight correction and Eyecup 4S.

Eyepiece Shutter: Built-in. Keeps out extraneous light during self-timer or remote control operation.

Mirror: Instant-return type with shock-absorbing mechanism. No image cut-off in the viewfinder even with the FD 400mm telephoto lens.

AE Mechanism. Electronically controlled. Information input by means of AE mode selector and AT dial for full-aperture AE metering (FD lens at "A") and stopped-down AE metering.

Employs three LSI's with 1^2L , one Linear LSI and one Bi-MOS IC for light metering.

AE Mode Selection: By means of AE mode selector. Two settings: Tv (Time value) for shutter-speed priority AE, Av (Aperture value) for aperture priority AE.

Light Metering System: Through-the-lens Central Emphasis metering by silicon photocell located just above eyepiece lens. Light reaches silicon photocell after passing through fresnel lens condenser.

ASA Film Speed Setting: ASA6 to ASA 12800 in $1/3$ step increments. With lock.

Meter Coupling Range: EV-2 (8 sec. at $f/1.4$) to EV 18 ($1/1000$ sec. at $f/16$) at ASA 100 with FD 50mm $f/1.4$ S.S.C. lens.

Exposure Compensation: ± 2 f/stop range in $1/3$ f/stop increments: $1/4 \cdot 1/2 \cdot 1 \cdot 2 \cdot 4$.

Exposure Memory: EV locked in when exposure memory switch is pressed. When pressed, the shutter-speed/aperture combination can be changed for the same

locked-in EV.

Exposure Preview: Viewfinder digital read-out activated by pressing shutter button halfway or by pressing exposure preview switch or exposure memory switch.

Stop-down Lever: Foldable. Stopping-down an FD lens is possible only when aperture ring is disengaged from "A" mark.

Manual Override: Possible by disengaging FD lens from "A" mark and setting AE mode selector to Tv. Aperture manually controlled with aperture ring, shutter speed with AT dial.

Shutter: Cloth focal plane shutter with four spindles. Electronically controlled, steplessly, from 30 sec. to $1/1000$ sec. Shock and noise damper mechanisms are incorporated.

Shutter Speed Scale: B, 30, 15, 8, 4, 2, 1, 2, 4, 8, 15, 30, 60, 125, 250, 500, 1000 plus P (with the AE mode selector at Tv). "P" setting is for programmed AE mode. Intermediate speeds not on the scale cannot be set.

Aperture Scale: $\cdot 1.4 \cdot 2 \cdot 2.8 \cdot 4 \cdot 5.6 \cdot 8 \cdot 11 \cdot 16 \cdot 22$ (with the AE mode selector at Av).

Shutter Release Button: Oversized, two-step button with electromagnetic shutter

release. Pressing it halfway activates meter circuit, pressing it all the way sets shutter in operation. Can be locked by setting main switch to "L" to guard against accidental shutter release. With cable release socket.

Power Source: One 6V silver oxide battery (Eveready No. 544, UCAR No. 544, JIS 4G13, Mallory PX28) or alkaline manganese battery (Eveready No. 537, UCAR No. 537). The battery lasts approximately one year under normal use. Battery is loaded in the battery chamber on the front of the camera body.

Battery Check: A red LED on top of camera flashes on and off to indicate power level when battery check button is pressed. Flashing frequency decreases with power level.

Main Switch: Two positions: "A" and "L". At "L" all active circuits are off and shutter button is locked as safety feature. Doubles as self-timer lever.

Cancellation of Camera Circuit: Shutter and self-timer operation cancelled by setting main switch to "L" or by pressing battery check button.

Multiple Exposure: Possible by setting multiple exposure lever before winding film advance lever to recock shutter. Frame counter does not advance. Automatically resets. Unlimited.

Self-Timer: Electronically controlled. Activated by pressing shutter button. Time-lag of 2 or 10 seconds possible. Red LED flashes on and off to indicate its operation. Flashing frequency increases 2 sec. before shutter release.

Flash Synchronization: X-synch at 1/60 sec.; FP- and M-synch at 1/30 sec. and slower.

Flash Coupling: Accessory shoe has contacts for directly-coupled flash units and automatic flash control contacts for automatic exposure. JIS-B (PC) type flash terminal with shock preventive rim on front of body.

Automatic Flash: Full AE flash photography with Canon Speedlites 155A and 199A. Shutter speed automatically set. Aperture automatically controlled according to setting of flash when flash is fully charged.

Back Cover: Opened by pulling up rewind knob. Removable for attaching Data Back A. With memo holder.

Film Loading: Easy film loading with multi-slot take-up spool.

Film Advance Lever: Single-stroke 120° throw with 30° stand-off. Winding with several short strokes possible. Automatic winding possible by mounting Canon Motor Drive MA or Power Winder A.

Frame Counter: Additive type. Counts